



rayhil

redefine brilliance

ABOUT US

The Rayhil Sonic Downlights boast an exceptional 90+ CRI light while simultaneously reaching substantial lumen counts on each model. The sleek design of the Downlights are just as practical as they are appealing. Air-tight and wet location approved, as well as Type IC Quid undusciam arit, nonsequia andio eossitat. Xeratus magnateste resciiis que di quidi ut quasimin parum experitis sit eici core suntocuptat omnis aliquam quae periamus nobit ea doluptae rero bero voloressus, unt id

The Rayhil Sonic Downlights boast an exceptional 90+ CRI light while simultaneously reaching substantial lumen counts on each model. The sleek design of the Downlights are just as practical as they are appealing. Air-tight and wet location approved, as well as Type IC Quid undusciam arit, nonsequia andio eossitat. Xeratus magnateste resciiis que di quidi ut quasimin parum experitis sit eici core suntocuptat omnis aliquam quae periamus nobit ea doluptae rero bero voloressus, unt id

redefine brilliance



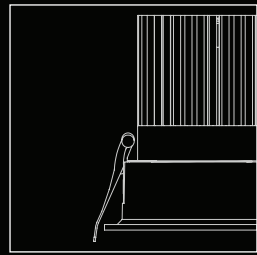

SONIC RECESSED DOWNLIGHT
pg. 6-15

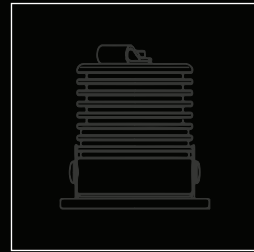

SONIC 1.0 MINI DOWNLIGHT
pg. 16-17

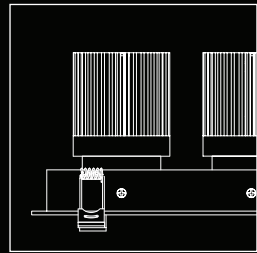

SONIC MULTIPLE RECESSED DOWNLIGHT
pg. 18-19

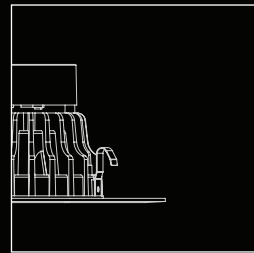

SONIC RETROFIT DOWNLIGHT
pg. 20-21

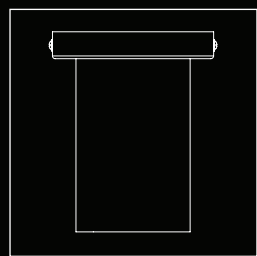

REVOLVE CYLINDER
pg. 22-25

PARKLINE OVERBED LIGHT
pg. 26-27

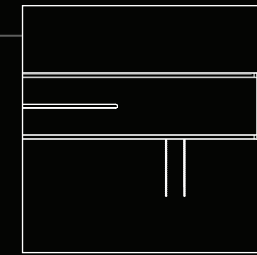

LEXLINE LINEAR
pg. 28-29

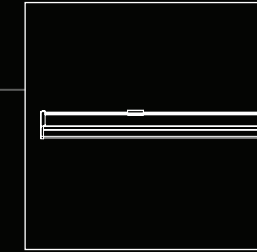

STRIKE
pg. 30-31

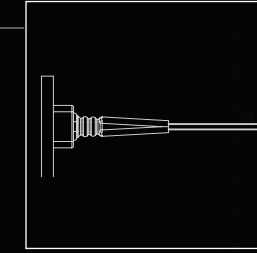

GENESIS STRIP LIGHT SERIES
pg. 32-33

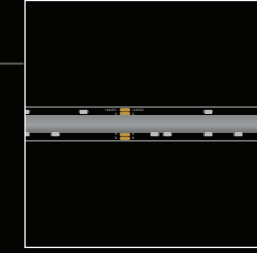

FUSE LINKABLE LINEAR
pg. 34-35

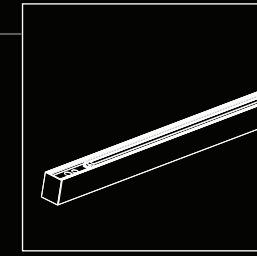

SONIC RECESSED DOWNLIGHT

The Rayhil Sonic Downlights boast an exceptional 90+ CRI light while simultaneously reaching substantial lumen counts on each model. The sleek design of the Downlights are just as practical as they are appealing. Air-tight and wet location approved, as well as Type IC

rated – approved for direct contact with insulation. They are also equipped with an Isolated driver inside a junction box. Available in multiple color temperatures, trim colors and shapes, as well as sizes.

Collection

Sonic

Series

Recessed Downlights

Features

Spring loaded mounting

clips, quick connect

wire allows for efficient

installation

Material

Aluminum

Efficacy

>82 lm/W

Environment

IP65

Dimming

Triac/ 0-10V

CRI

>90

Operating Temperature

-4°F - 104°F

Accessories

New Construction Plate

Emergency Backup

Trim Colors

Lamp Life

50,000 hours

Warranty

5 years

SONIC

1.5 RECESSED DOWNLIGHT

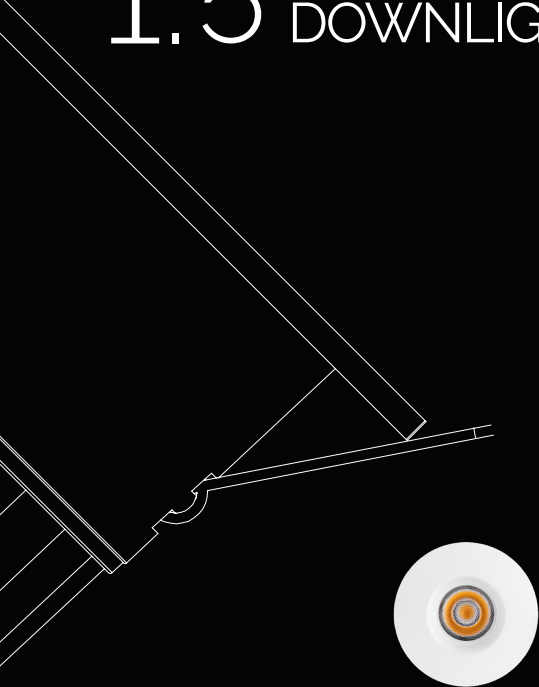

RAD15R-7

ROUND
7W
600LM
2.5" X 2.7"

RAD15S-7

SQUARE
7W
600LM
2.5" X 2.7"

ADDITIONAL INFO

- Input Voltage: 120V or 277V
- Color Temp.: 30K, 35K, 40K
- Cut Out: 2 inch
- Beam Angle: 36°

ACCESSORIES

- Trim Color: White, Black, Brushed Nickel, Gold, Bronze
- New construction plate available (NCH150)
- Optional Emergency Backup RAD15-EM

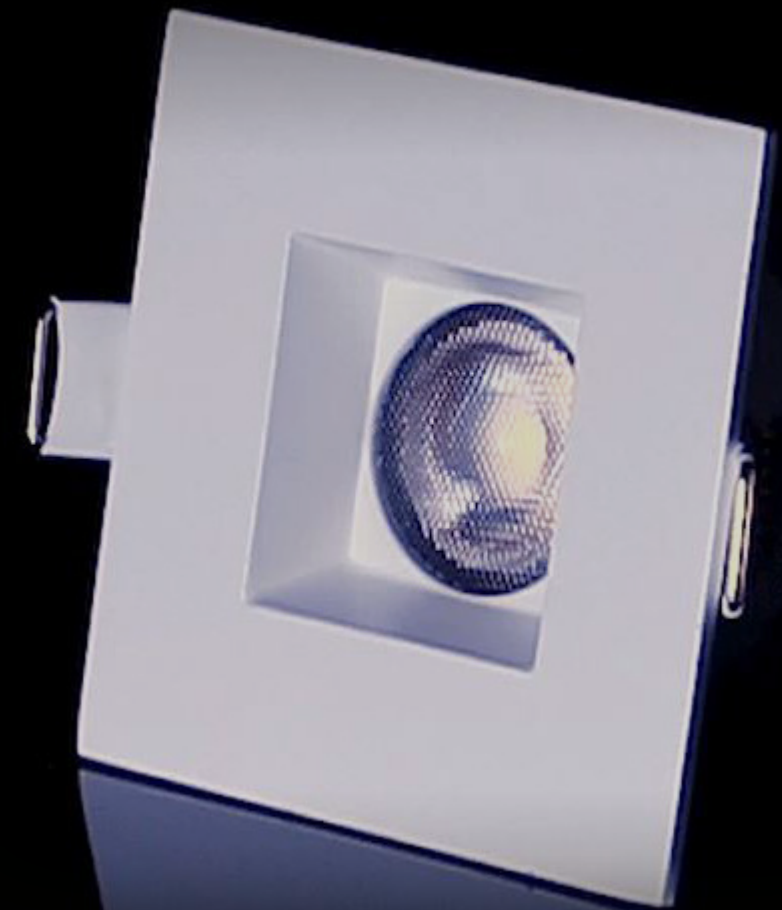

SONIC

2.5 RECESSED DOWNLIGHT

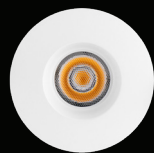
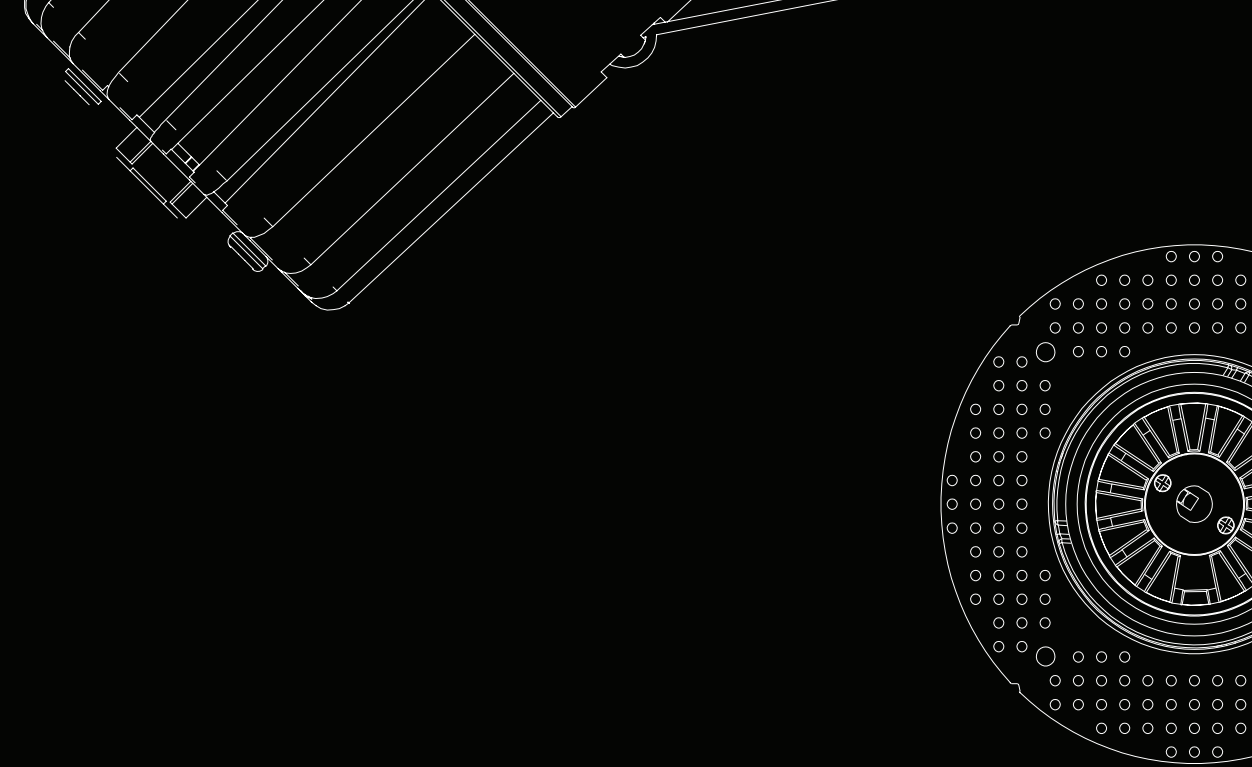

RAD25R-9-CCT

ROUND
9W
800LM
3" X 3.15"

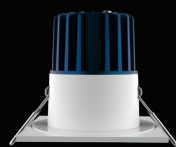

RAD25S-9-CCT

SQUARE
9W
800LM
3" X 3.15"

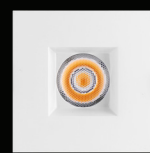

HIGH LUMENS

RAD25S-14-CCT

SQUARE
14W
1100LM
4.87" X 3.15"



HIGH LUMENS

RAD25R-14-CCT

ROUND
14W
1100LM
4.87" X 3.15"

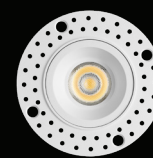

RAD25TMS-R-9-CCT

ROUND
9W
800LM
3.94" X 2.81"

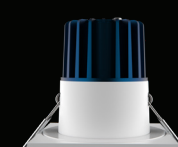

RAD25TMS-S-9-CCT

SQUARE
9W
800LM
3.94" X 3.04"

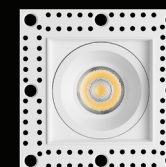

RAD25TMS-S-14-CCT

SQUARE
14W
1100LM
3.94" X 4.85"



RAD25TMS-R-14-CCT

BASE
14W
1100LM
3.94" X 4.62"

ADDITIONAL INFO

- Input Voltage: 120V or 277V
- CCT: 27K, 30K, 35K, 40K, 50K (CCT ADJ.)
- Cut Out: 2.36 inch
- Beam Angle: 15° / 24° / 38°

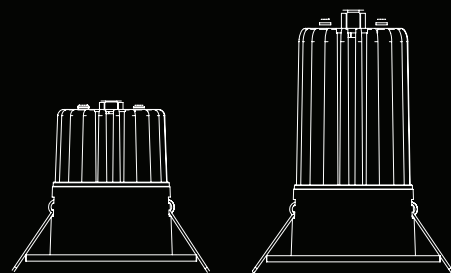

ACCESSORIES

- Trim Color: White, Black, Brushed Nickel, Gold, Bronze **NOT AVAILABLE FOR TRIMLESS OPTION*
- New Construction Plate available (NCH250)
- Optional Emergency Backup RAD25/35-EM

SONIC

3.5 RECESSED DOWNLIGHT

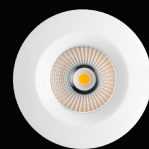
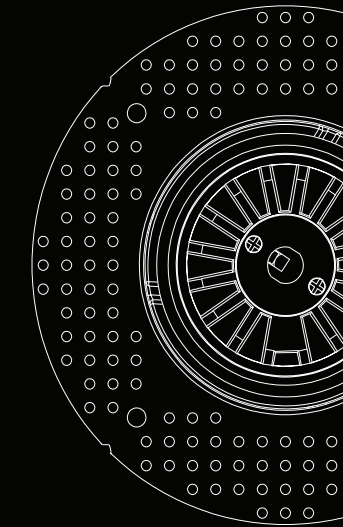
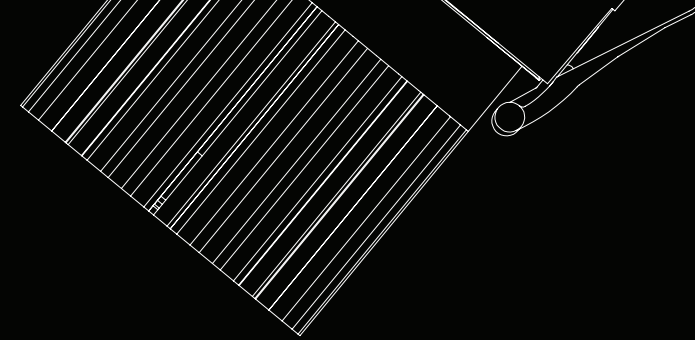
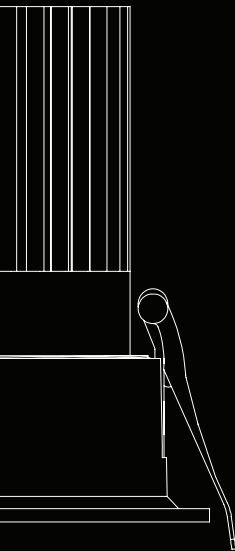

RAD35R-15-CCT

ROUND
15W
1250LM
3.75" X 4.40"

RAD35S-15-CCT

SQUARE
15W
1250LM
3.75" X 4.40"

GIMBAL

RAD35R-12G-CCT

ROUND
12W
850LM
4" X 3"

ADDITIONAL INFO

- Input Voltage: 120V or 277V
- CCT: 30K, 35K, 40K (CCT ADJ.)
- Cut Out: 3.5 inch
- Beam Angle: 15° / 24° / 42° / 55°

ACCESSORIES

- Trim Color: White, Black
- New construction plate available (NCH350)
- Optional Emergency Backup RAD25/35-EM

RAD35TMS-R-15-CCT

ROUND
15W
1250LM

ADDITIONAL INFO

- Input Voltage: 120V or 277V
- CCT: 20K, 30K, 35K, 40K, 50K (CCT ADJ.)
- Cut Out: 3.74 inch
- Beam Angle: 24° / 36° / 50°

ACCESSORIES

- New construction plate available (NCH350)
- Optional Emergency Backup RAD25/35-EM

ACCESSORIES

- Trim Color: White, Black, Brushed Nickel, Gold, Bronze
- New construction plate available (NCH350)
- Optional Emergency Backup RAD25/35-EM

ADDITIONAL INFO

- Input Voltage: 120V or 277V
- CCT: 27K, 30K, 35K, 40K, 50K (CCT ADJ.)
- Cut Out: 3.5 inch
- Beam Angle: 24° / 36° / 50°

Our most powerful Downlight yet, the Sonic X 3.5, offers 2000lm of light with only 23W of energy consumption. This powerhouse exceeds all expectations with its illumination ability without compromising its sleek and compact size. As with all Sonic Downlight Series products, this model features an aluminum body, an anodized heat sink, and a galvanized steel trim. This solid design ensures the Sonic X 3.5 can offer premium lighting and durability in various settings, including wet locations or unusual ceiling heights. Furthermore, this fixture is available in two shapes, square and round, as well as numerous trim colors to meet your interior design needs.

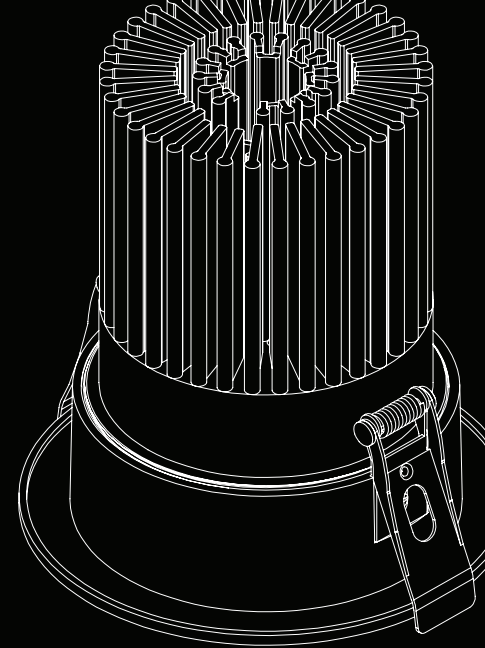
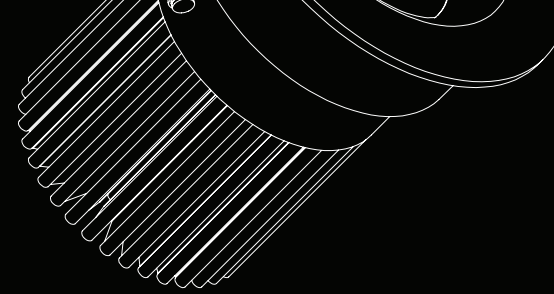

SONIC X

RAD35S-23-CCT

SQUARE

23W

2000LM

4.13" X 4.72"



SONIC X

RAD35R-23-CCT

ROUND

23W

2000LM

4.37" X 4.72"

ADDITIONAL INFO

- Input Voltage: 110V or 277V
- CCT: 27K, 30K, 35K, 40K, 50K (CCT ADJ.)
- Cut Out: 3.5 inch
- Beam Angle: 24° / 36° / 50°

ACCESSORIES

- Trim Color: White, Black, Brushed Nickel, Gold, Bronze
- New construction plate available (NCH350)
- Optional Emergency Backup RAD25/35-EM

SONIC X

RECESSED DOWNLIGHT

SONIC 1.0 MINI

The Sonic Mini 1.0 Downlights combine functionality, strength and appeal into a one inch compact fixture. Ideal for inside cabinets, display cases, and other decorative positions. Each Mini Downlight delivers 400 lumens and 90+ CRI light. An extruded aluminum heat sink ensures optimal heat

dissipation and LED life. Multiple color temperatures and shape options available, and suitable for wet locations.

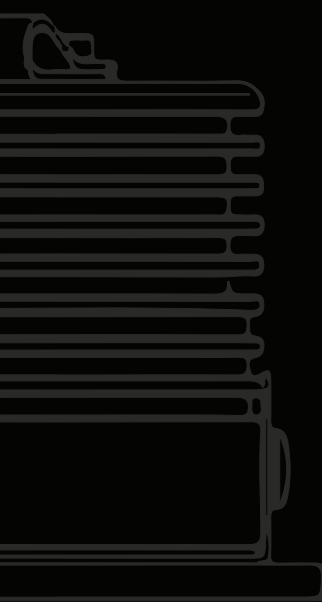
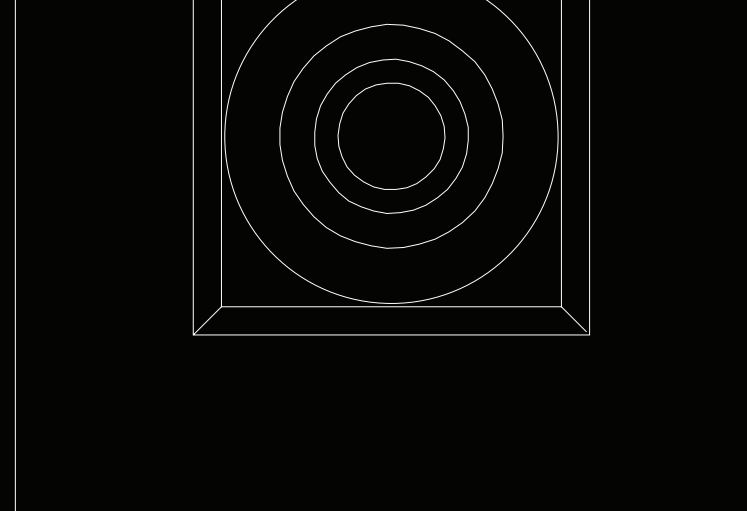
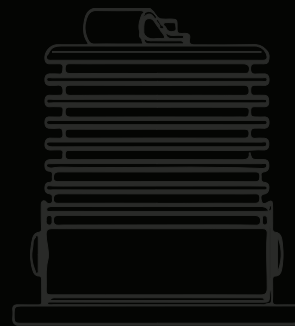

Collection
Sonic Mini
Series
Recessed Downlights
Material
Aluminum
Efficacy
>60 lm/W
Voltage
24V

Environment
IP40
Dimming
Dimmable
CRI
>90
Operating Temperature
-4°F - 104°F

Lamp Life
50,000 hours
Warranty
5 years

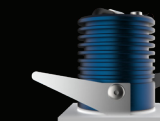

RAD10R-5

ROUND
5W
400LM
1.57" X 1.72"

RAD10S-5

SQUARE
5W
400LM
1.57" X 1.72"

ADDITIONAL INFO

- Input Voltage: 24V
- CCT: 30K, 35K, 40K
- Cut Out: 1.33 inches
- Beam Angle: 60°

SONIC MULTIPLE

The Rayhil Sonic Multiple Series cultivates a fresh unique look that defines any commercial or residential space. The flawless engineering of the extruded aluminum heat sink ensures optimal heat dissipation and LED life. The Multiple Head Downlights are Type IC rated – approved for direct contact with insulation and have

an isolated driver inside a junction box. Additionally, they are air-tight and wet location approved. The gimbal can rotate 360 degrees horizontally and tilt 30 degrees. Available in both 2-Head and 3-Head as well as multiple color temperature and trim options.

Collection
Sonic Multiples
Series
Recessed Downlights
Material
Aluminum
Efficacy
>77 lm/W
Features
360° rotatable Gimbal
with 30° horizontal tilt

Environment
Damp Location
Dimming
Triac/ 0-10V
CRI
>90
Operating Temperature
-4°F - 104°F

Accessories
New Construction Plate
Trim Colors
Lamp Life
50,000 hours
Warranty
5 years

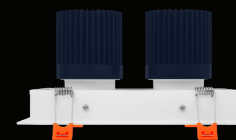
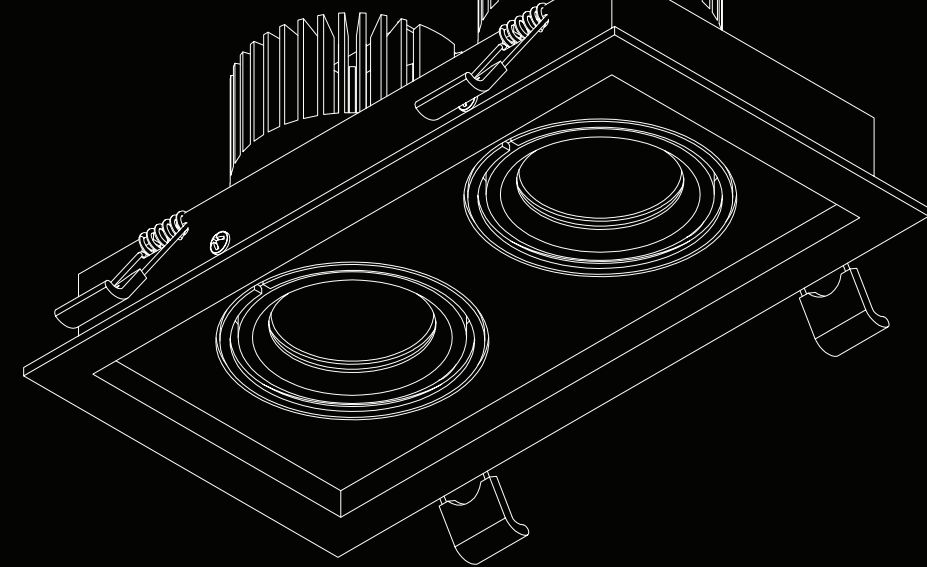

RAD-2H-12

2 HEAD
12W X 2
1750LM
8" X 4.25" X 4"

ADDITIONAL INFO

- Input Voltage: 120V or 277V
- CCT: 27K, 30K, 35K, 40K, 50K (CCT ADJ.)
- Cut Out: 7 1/2" x 3 3/4"
- Beam Angle: 15° / 24° / 38°

ACCESSORIES

- Trim Color: White, Black
- New construction plate available (NCH2H)

RAD-3H-12

3 HEAD
12W X 3
2700LM
11.5" X 4.25" X 4"

ADDITIONAL INFO

- Input Voltage: 120V or 277V
- CCT: 30K, 35K, 40K (CCT ADJ.)
- Cut Out: 10 7/8" x 3 3/4"
- Beam Angle: 15° / 24° / 38°

ACCESSORIES

- Trim Color: White, Black
- New construction plate available (NCH3H)

SONIC RETROFIT DOWNLIGHT

The Rayhil Sonic Retrofits were crafted with innovative efficiency and aesthetic perfectionism. The versatility of the E26 and MR16 base options, plus the multiple color temperatures, trim colors and shapes, as well as sizes, make the Retrofit Series achieve your lighting desires with ease.

Each Retrofit displays exceptional 90+ CRI light while delivering over 75 lumens per watt. Compatible with both 4" New construction and 4" Remodel Housings. In addition, the Retrofits are suitable for wet location.

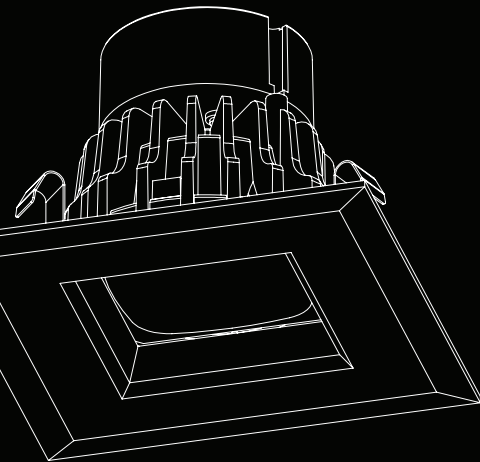
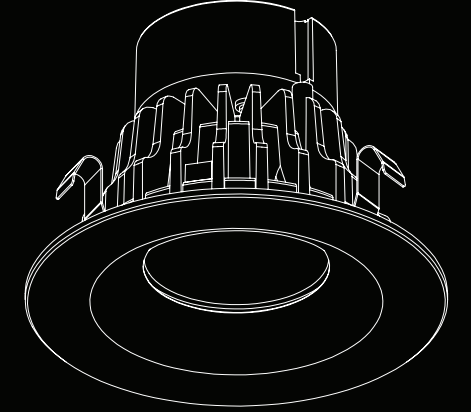
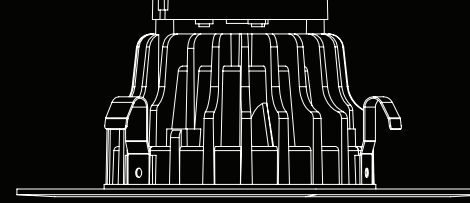
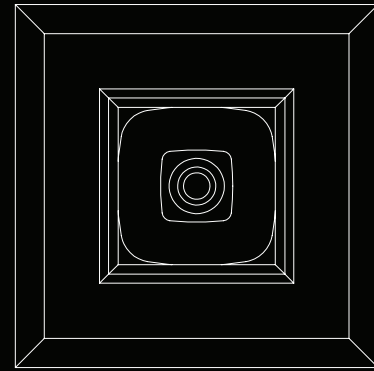

Collection
Sonic
Series
Recessed Retrofit
Base
E26
MR16
Material
Aluminum

Efficacy
>75 lm/W
Environment
IP65
Dimming
Triac/ 0-10V
CRI
>90
Operating Temperature
-4°F - 104°F

Accessories
New Construction Housing
Trim Colors
Lamp Life
50,000 hours
Warranty
5 years

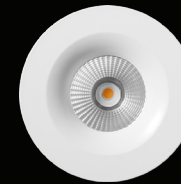

RAR40R-10-CCT

ROUND
10W
1000LM
4.94" X 3.375"
E26 BASE

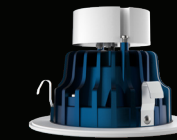

RAR40R-10-CCT-MR16

ROUND
10W
1000LM
4.94" X 3.375"
MR16 BASE



RAR40S-10-CCT

SQUARE
10W
1000LM
4.94" X 3.375"
E26 BASE

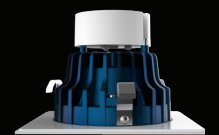

RAR40S-10-CCT-MR16

SQUARE
10W
1000LM
4.94" X 3.375"
MR16 BASE

ADDITIONAL INFO

- Input Voltage: 120V or 12V
- CCT: 30K, 35K, 40K (CCT ADJ.)
- Beam Angle: 24° / 36° / 50°

ACCESSORIES

- Trim Color: White, Black, Brushed Nickel, Gold, Bronze
- New Construction Housing LB15147

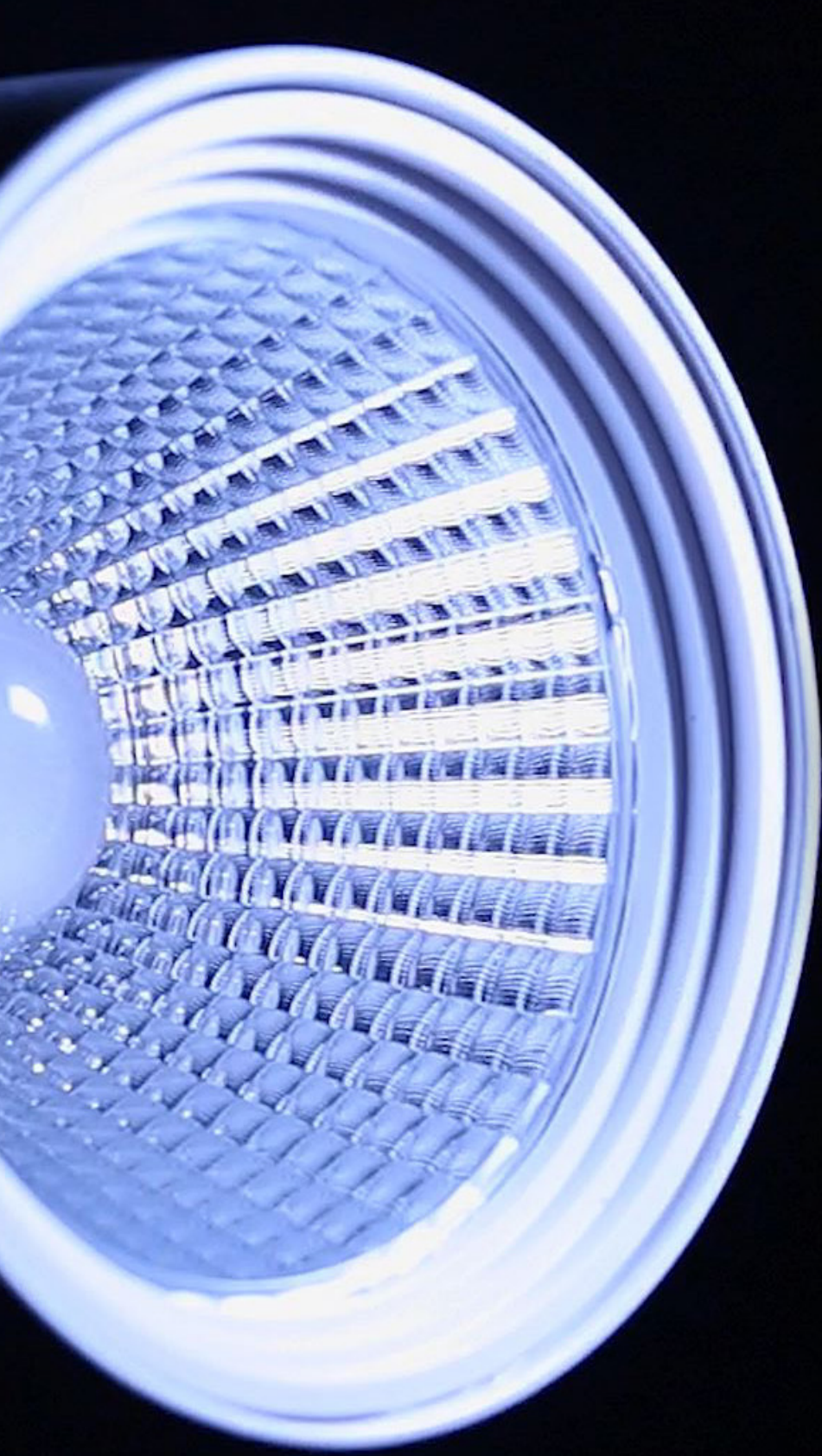

REVOLVE

CYLINDER



REVOLVE

CYLINDER

Collection
Revolve
Series
Cylinder
Wattage
20W
Voltage
120V - 277V
Efficacy
>90 lm/W

CRI
>90
Environment
Damp Location
Dimming
Triac/ 0-10V
Operating Temperature
-4°F - 104°F
Beam Angle
40°

Trim Finish
White
Kits
Surface Mounting Kit
Pendant Mounting Kit
Trimless Mounting Kit
Lamp Life
50,000 hours
Warranty
5 years



CYL-20-CCT
CYLINDER MODULE

The Revolve Cylinder Series provides a minimalistic lighting element to your space. The Black and White finish options allow you to match your fixture to your aesthetic. The interchangeable Mounting Kits ensure smooth installation and a versatile adaptation



CYL-SFC
SURFACE MOUNTING KIT
BLACK | WHITE
4.72" X 5.87"



CYL-PDT
PENDANT MOUNTING KIT
BLACK | WHITE
4.72" X 4 FT ADJ.



CYL-TMS
TRIMLESS MOUNTING KIT
WHITE
5.20" X 0.12"

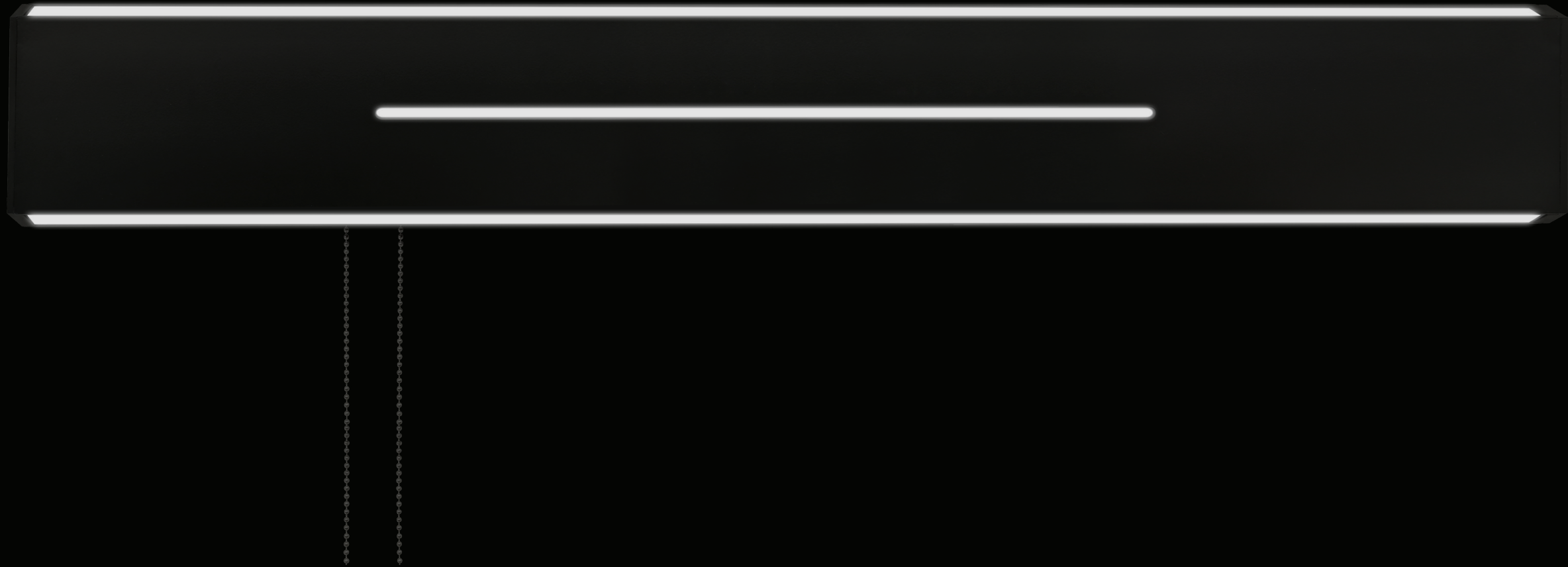

The Parkline Overbed Light was meticulously designed with the intention of providing the Hospitality Industry with a solution that would exceed any expectation. An equal combination of aesthetic and maximum performance harmoniously powers the Parkline. The 3 directional lights provide multiple options for illumination such as a Reading Light, Ambient Light and a Night Light which can function

individually as well as in unison. Standard finish options include White, Brushed Nickel, Gold and Black. Custom finishes and lengths are available to meet the exact vision imagined. Field selectable Wattage and Color Temperature switches located behind the fixture grant the flexibility to add yet another customized feel to any room they are placed in.

PARKLINE™

STARTING OPTION

Pull Chain
 1 Ft | 2 Ft | 3 Ft | Custom
 Left | Center | Right
 Hand Remote
 Wire | Wireless

FINISHES

White | Black | Gold
 Brushed Nickel
 Custom

POL-2-CCT

10W / 15W / 20W + 5W

POL-3-CCT

10W / 20W / 30W + 5W

POL-4-CCT

20W / 30W / 40W + 5W

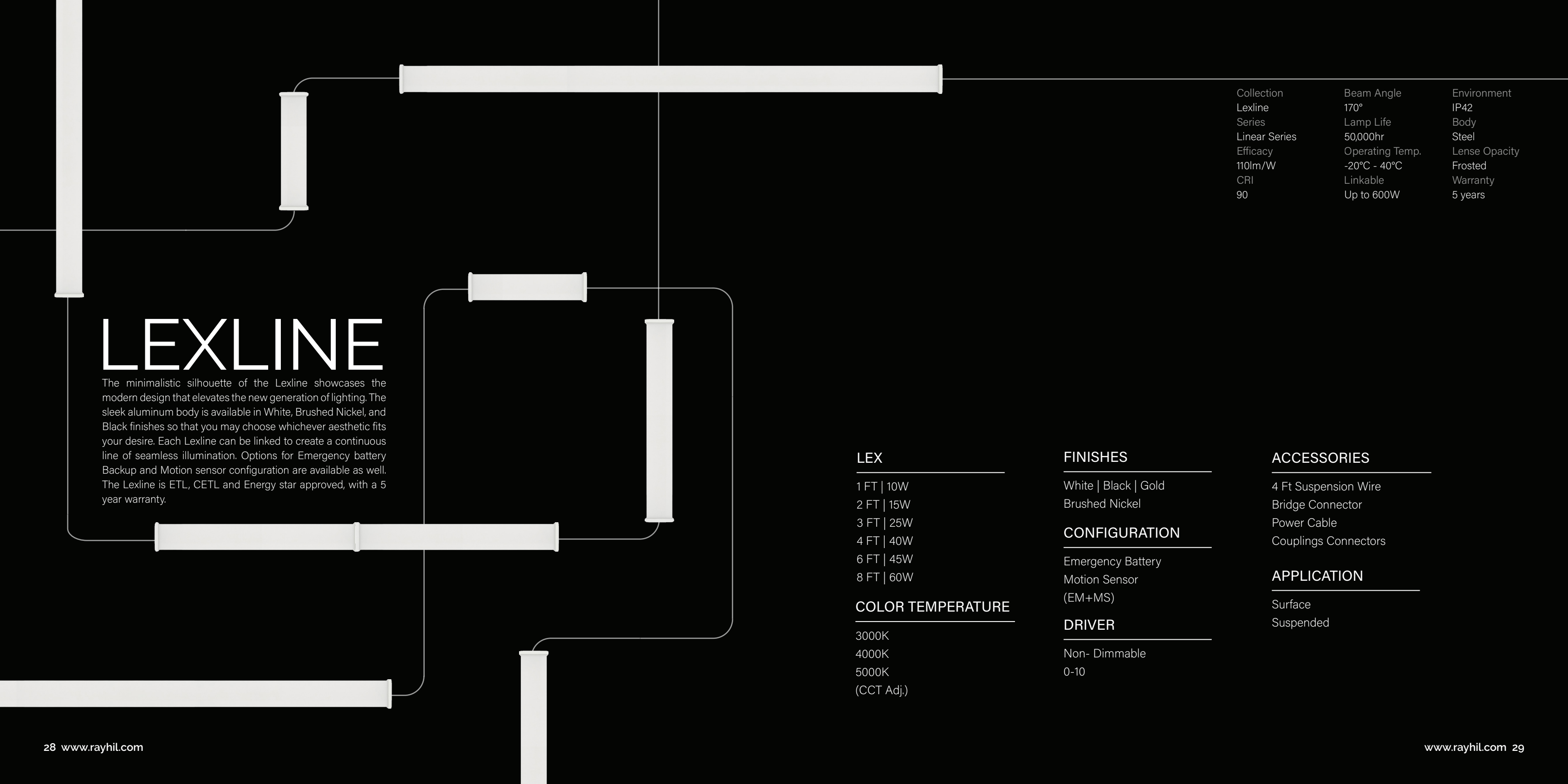

LEXLINE

The minimalistic silhouette of the Lexline showcases the modern design that elevates the new generation of lighting. The sleek aluminum body is available in White, Brushed Nickel, and Black finishes so that you may choose whichever aesthetic fits your desire. Each Lexline can be linked to create a continuous line of seamless illumination. Options for Emergency battery Backup and Motion sensor configuration are available as well. The Lexline is ETL, CETL and Energy star approved, with a 5 year warranty.

Collection	Beam Angle	Environment
Lexline	170°	IP42
Series	Lamp Life	Body
Linear Series	50,000hr	Steel
Efficacy	Operating Temp.	Lense Opacity
110lm/W	-20°C - 40°C	Frosted
CRI	Linkable	Warranty
90	Up to 600W	5 years

LEX

- 1 FT | 10W
- 2 FT | 15W
- 3 FT | 25W
- 4 FT | 40W
- 6 FT | 45W
- 8 FT | 60W

COLOR TEMPERATURE

- 3000K
- 4000K
- 5000K
- (CCT Adj.)

FINISHES

- White | Black | Gold
- Brushed Nickel

CONFIGURATION

- Emergency Battery
- Motion Sensor
- (EM+MS)

DRIVER

- Non- Dimmable
- 0-10

ACCESSORIES

- 4 Ft Suspension Wire
- Bridge Connector
- Power Cable
- Couplings Connectors

APPLICATION

- Surface
- Suspended

STRIKE

series grants creative opportunities that are seldom seen in the Lighting industry. Each space can be uniquely transformed by these LED Linear Strips. Unlimited shapes and formations can be designed to ensure a timeless intrigue. The COB Strip technology creates a seamless and transitional light output, without any interruptions such as with standard LED Chips. Black and White finishes available.

Collection	Lumens	Weight
Strike	400lm/W	0.252kg/m
Series	Diffuser	Material
Linear Series	PC diffused cover	Silicone
Wattage	Length	Installation
4.6W/FT	Custom up to 40ft.	Wall Mounting
Voltage	Max LED Strip Width	Warranty
24V	10mm	5 years

STK

4.6W/FT
Custom length available up to 40 ft.

FINISHES

Black
White (custom order)

COLOR TEMPERATURE

3000K
3500K
4000K

ADDITIONAL INFO

- Runs can not exceed 20 feet per home run
- Maximum driver distance of 20 feet before voltage drop (with 18 gage wire)
- Compatible with electronic driver only

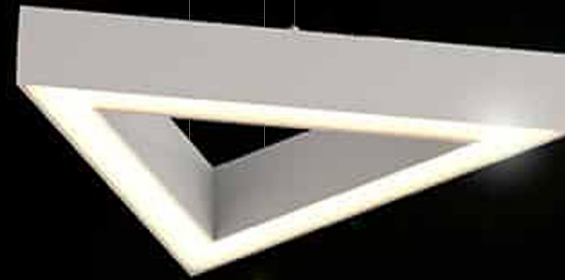

FUSE LINKABLE LINEARS

The Fuse linkable linear series creates opportunity to explore illumination with sleek and versatile linear fixtures. Direct and Direct/Indirect light options allows for optimal light distribution, and the Linkable X, Y, V and T shapes open the door to countless design formations. Multiple mounting applications are available as well as black and white finish options.



Collection	Input Voltage	Dimming
FUSE	120V	0-10V
Series	CRI	Dimensions
Linear Series	>80	W 2" x H 3"
Lumens	Beam Angle	Environment
115lm/W	100°	IP40
Driver Efficacy	Lifetime	Warranty
>87%	50,000hr	3 years

FUSE

- 4 FT
- 8 FT
- L
- X
- T
- Y

COLOR TEMPERATURE

- 3000K
- 4000K
- 5000K
- (CCT Adj.)

FINISHES

- White | Black
- Brushed Nickel

DIRECTION

- Direct
- Indirect

WATTAGE

- 40W 4600LM
- 80W

LENSE

- Flat Lens
- Louver Lens
- Drop Lens (1/2")
- Rolled Lens (LENGTH)

APPLICATION

- Surface
- Suspended
- Recessed
- Trimless Recessed
- Wall Mount

redefine brilliance

RAYHIL CORP.

WINTER 2023