

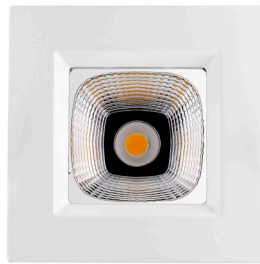

# RAD35 SONIC 3.5

## 3.5" RECESSED LED DOWNLIGHT

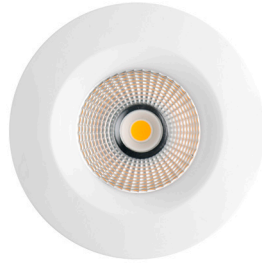

### FEATURES

- Air-tight and wet location approved
- Type ic rated - approved for direct contact with insulation
- Downlight housing is not required even for insulated ceilings
- Spring loaded mounting clips
- Quick connect wire allows for efficient installation
- Isolated driver inside junction box
- New construction plate available (NCH350)
- Optional Emergency Backup
- 5 year warranty

### SPECIFICATIONS

Input Voltage	120 or 277V AC
Wattage	15W
Lumen	1250lm
Efficacy(LPW)	>82 lm/W
Color Temp	27K, 30K, 35K, 40K, 50K (CCT adj.)
CRI	>90
Beam Angle	24° / 36° / 50°
Dimming	Triac or 0-10V (with 277V driver)
Lamp Life	50,000hr
Environment	IP65 Wet Location
Material	Aluminum Body with Anodized Heat Sink
Operating Temp	-4°F - 104°F
Cut out	3.5 inches

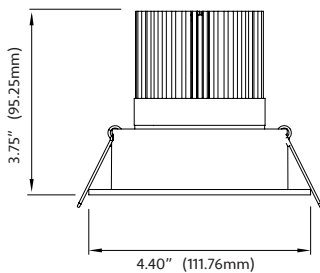

### LUMINOUS INTENSITY DISTRIBUTION DIAGRAM

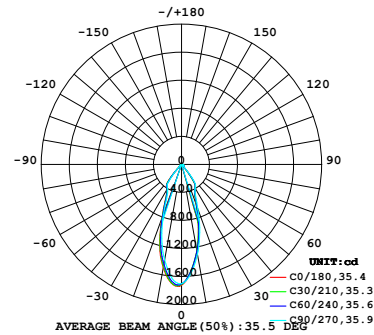

### ORDERING GUIDE

**RAD35** \_\_\_\_ - **15** - \_\_\_\_\_ - \_\_\_\_\_ - \_\_\_\_\_ - \_\_\_\_\_ *Example: RAD35R-15-CCT-120-24C-WT-EM*

Trim	Wattage	Color Temperature	Input Voltage	Beam Angle	Lense	Trim Finish	EM
RAD35R (Round)	15 (1250lm)	CCT Adj.	120 (Triac Dim)	24°	C Clear F Frosted P Pinhole W Wall Washing E Extension Plate 5"	WT White	EM
RAD35S (Square)		(27K, 30K, 35K, 40K, 50K)				277 (0-10V Dim)	
		3000K		50°		BN Brushed Nickel	
		3500K				GD Gold	
		4000K			BZ Bronze		
					CP Copper		

**\*QUICKSHIP CONFIGURATION - 120V 36 DEGREE BEAM ANGLE CLEAR LENSE**



# RAD35 SONIC 3.5

3.5" RECESSED LED DOWNLIGHT

## ACCESSORIES / OPTIONS

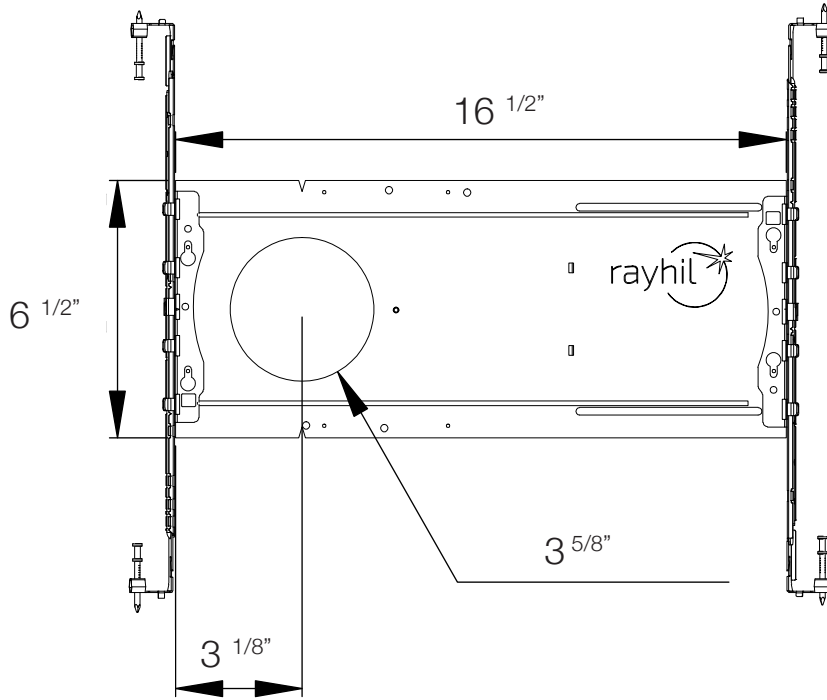

### NEW CONSTRUCTION MOUNTING PLATE NCH350

Constructed out of galvanized steel

Magnetic plate and driver facilitate easy and secure placement

Adjustable Hanger Bars up to 24"

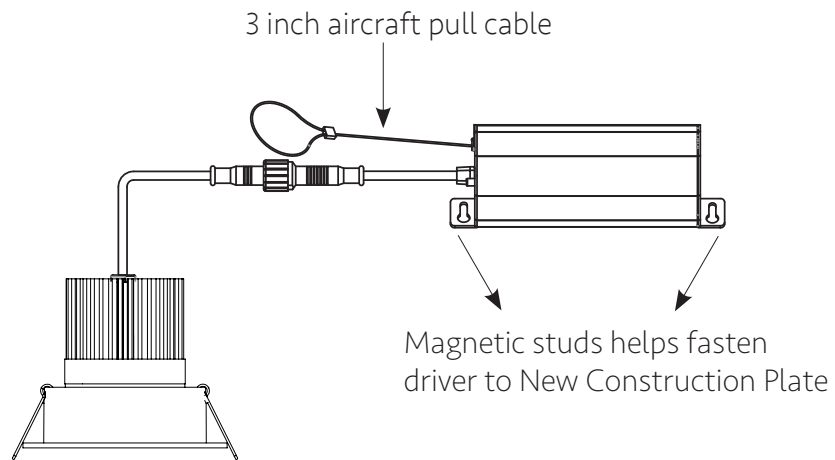



# RAD35 SONIC 3.5

3.5" RECESSED LED DOWNLIGHT

## TRIM COLOR OPTIONS

White	WT
Black	BK
Brushed nickel	BN
Gold	GD
Bronze	BZ
Copper	CP

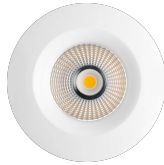

Existing Trim

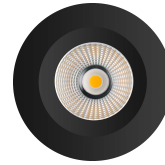

RAD35R-BK

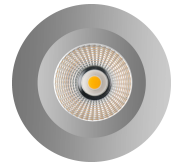

RAD35R-BN

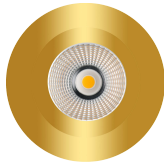

RAD35R-GD

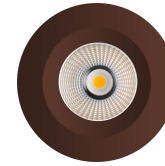

RAD35R-BZ

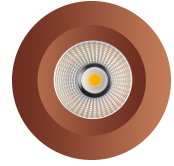

RAD35R-CP

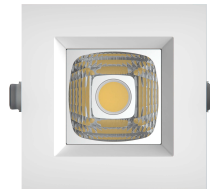

Existing Trim

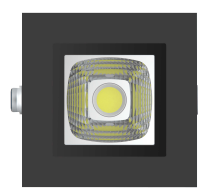

RAD35S-BK

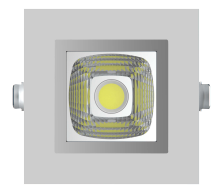

RAD35S-BN

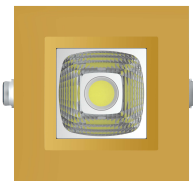

RAD35S-GD

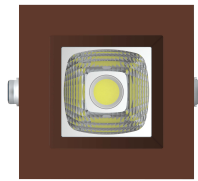

RAD35S-BZ

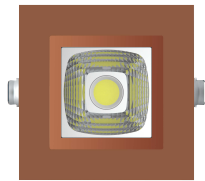

RAD35S-CP



# RAD35 SONIC 3.5

3.5" RECESSED LED DOWNLIGHT

## EMERGENCY BACK UP DRIVER

### RAD25/35-EM

90 minute run time

See spec sheet for further information

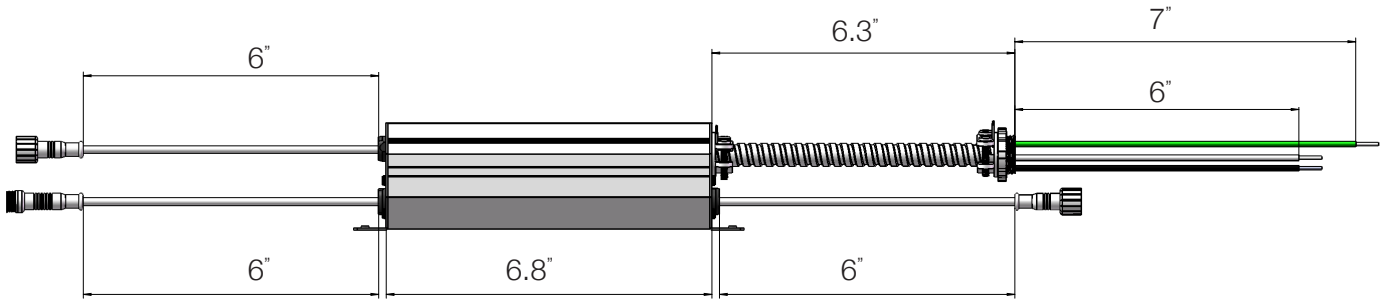
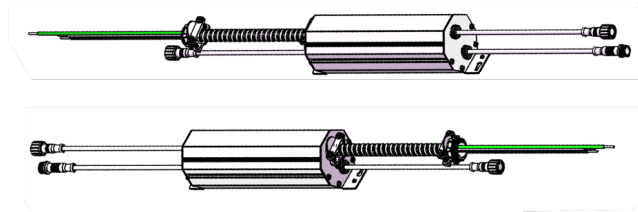



# RAD35 SONIC 3.5

3.5" RECESSED LED DOWNLIGHT

## COMPATIBLE DIMMERS

<b>LUTRON</b>	LOAD (W)	<b>LEVITON</b>	LOAD (W)
SKYLARK CONTOUR LECL-153P	150W	ILLUMATEC IPL06	150W
SKYLARK CONTOUR CTCL-150H	150W	SURESLIDE 6672	150W
SKYLARK CONTOUR LGCL-153PLH	150W	SURESLIDE 6674	150W
SKYLARK CONTOUR CTCL-153P	150W		
SKYLARK CONTOUR SCL-153P	150W	<b>EATON</b>	
SKYLARK CONTOUR S-600P	600W	SMART DIMMER AAL06	300W
CASETA PD-6WCL	600W		
CASETA PD-5NE	150W	<b>PASS &amp; SEYMOUR</b>	
CASETA PD-10NXD	250W	HARMONY DCL453PTCCCV6	150W
DIVA DVCL-153P	150W		
TOGGLER TGCL-153P	150W	<b>GE</b>	
ARIADNI AYCL-153P	150W	ROCKER 10464	150W
MAESTRO MACL-153M	150W	TOGGLE 18027	150W