

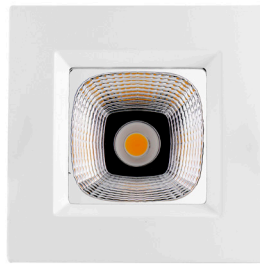

RAD35 SONIC 3.5

3.5" RECESSED LED DOWNLIGHT

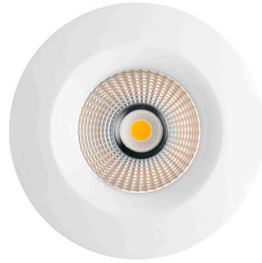

FEATURES

- Air-tight and wet location approved
- Type ic rated - approved for direct contact with insulation
- Downlight housing is not required even for insulated ceilings
- Spring loaded mounting clips
- Quick connect wire allows for efficient installation
- Isolated driver inside junction box
- New construction plate available (NCH350)
- Optional Emergency Backup
- 5 year warranty

SPECIFICATIONS

Input Voltage	120-277V
Wattage	15W
Lumen	1250lm
Efficacy(LPW)	>82 lm/W
Color Temp	27K, 30K, 35K, 40K, 50K (CCT adj.)
CRI	>90
Beam Angle	15° /24°/36°/50°
Dimming	Triac & 0-10V
Lamp Life	50,000hr
Environment	IP65 Wet Location
Material	Aluminum Body with Anodized Heat Sink
Operating Temp	-4°F - 104°F
Cut out	3.5 inches

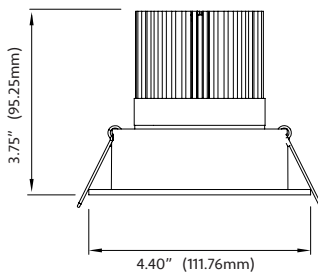

LUMINOUS INTENSITY DISTRIBUTION DIAGRAM

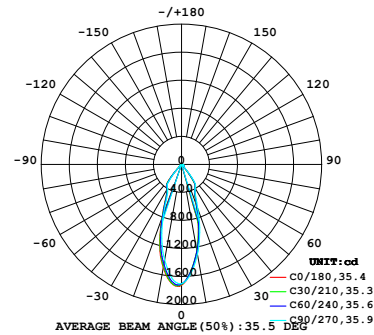

ORDERING GUIDE

RAD35 ____ - **15** - **- UNV -** ____ - ____ - ____ *Example: RAD35R-15-CCT-UNV-24C-WT-EM*

Trim	Wattage	Color Temperature	Input Voltage	Beam Angle	Lense	Trim Finish	EM
RAD35R (Round)	15 (1250lm)	CCT Adj. (27K, 30K, 35K, 40K, 50K)	UNV (120-277V)	15°	C Clear	WT White	EM
RAD35S (Square)				24°	F Frosted	BK Black	
				36°	P Pinhole	BN Brushed Nickel	
				50°	W Wall Washing	GD Gold	
				4000K	E Extension Plate 5"	BZ Bronze	
					CP Copper		

***QUICKSHIP CONFIGURATION - 120V 36 DEGREE BEAM ANGLE CLEAR LENSE**



RAD35 SONIC 3.5

3.5" RECESSED LED DOWNLIGHT

ACCESSORIES / OPTIONS

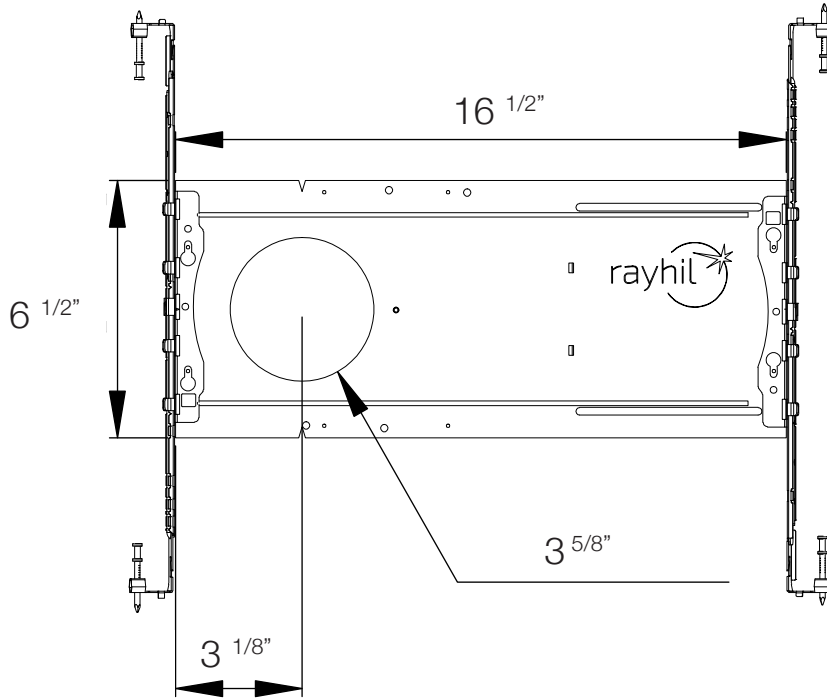

NEW CONSTRUCTION MOUNTING PLATE NCH350

Constructed out of galvanized steel

Magnetic plate and driver facilitate easy and secure placement

Adjustable Hanger Bars up to 24"

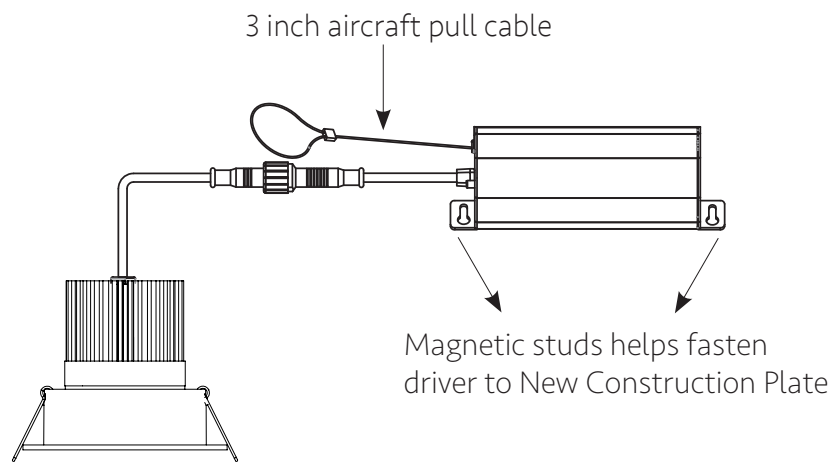



RAD35 SONIC 3.5

3.5" RECESSED LED DOWNLIGHT

TRIM COLOR OPTIONS

White	WT
Black	BK
Brushed nickel	BN
Gold	GD
Bronze	BZ
Copper	CP

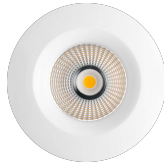

Existing Trim

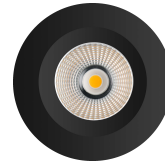

RAD35R-BK

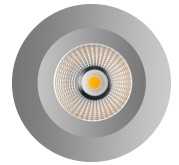

RAD35R-BN

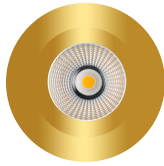

RAD35R-GD

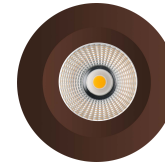

RAD35R-BZ

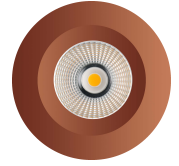

RAD35R-CP

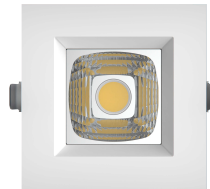

Existing Trim

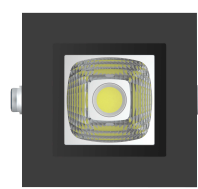

RAD35S-BK

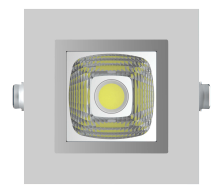

RAD35S-BN

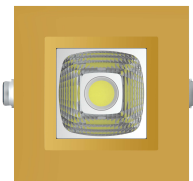

RAD35S-GD

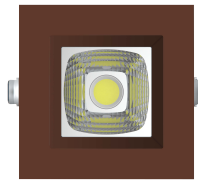

RAD35S-BZ

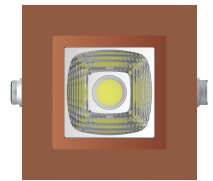

RAD35S-CP



RAD35
SONIC 3.5
3.5" RECESSED LED DOWNLIGHT

EMERGENCY BACK UP DRIVER

RAD25/35-EM

90 minute run time

See spec sheet for further information

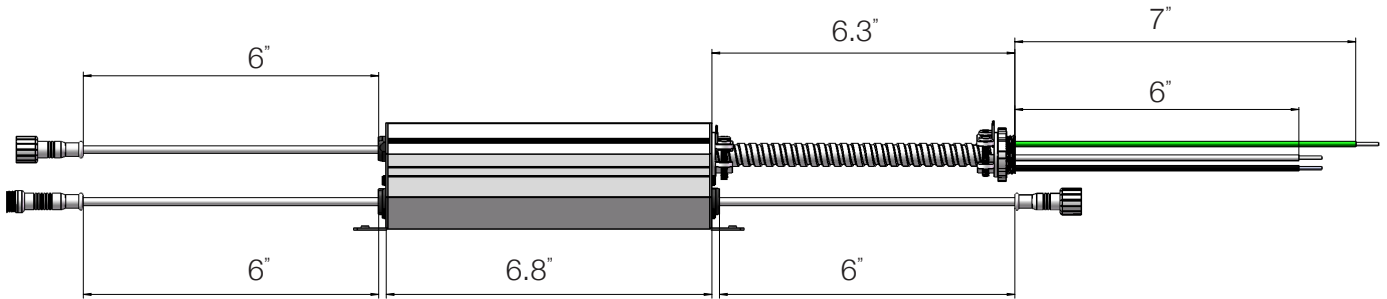
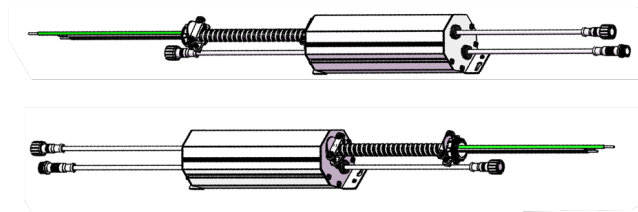



RAD35 SONIC 3.5

3.5" RECESSED LED DOWNLIGHT

COMPATIBLE DIMMERS

LUTRON	LOAD (W)	LEVITON	LOAD (W)
SKYLARK CONTOUR LECL-153P	150W	ILLUMATEC IPL06	150W
SKYLARK CONTOUR CTCL-150H	150W	SURESLIDE 6672	150W
SKYLARK CONTOUR LGCL-153PLH	150W	SURESLIDE 6674	150W
SKYLARK CONTOUR CTCL-153P	150W		
SKYLARK CONTOUR SCL-153P	150W	EATON	
SKYLARK CONTOUR S-600P	600W	SMART DIMMER AAL06	300W
CASETA PD-6WCL	600W		
CASETA PD-5NE	150W	PASS & SEYMOUR	
CASETA PD-10NXD	250W	HARMONY DCL453PTCCCV6	150W
DIVA DVCL-153P	150W		
TOGGLER TGCL-153P	150W	GE	
ARIADNI AYCL-153P	150W	ROCKER 10464	150W
MAESTRO MACL-153M	150W	TOGGLE 18027	150W