

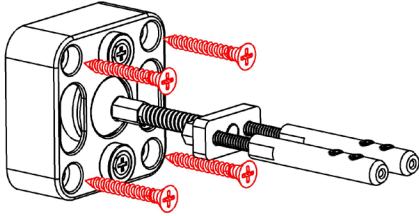

STK STRIKE

INSTALLATION GUIDE

1. Mounting the canopy on the wall



2. Cut off the excess TPV & PC diffused cover

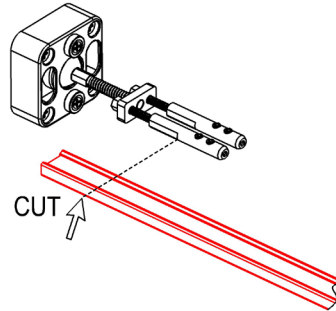

3. Leave a certain length of wire rope

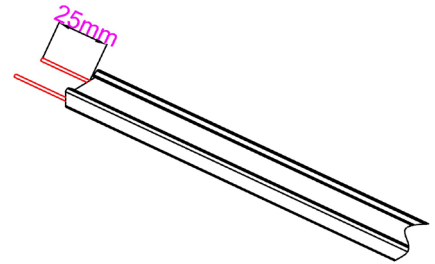

4. Stick the led strip

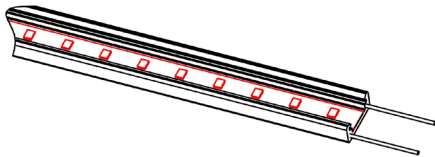

5. Click the PC diffused cover

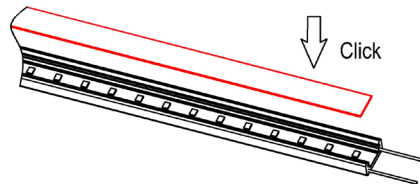

6. Remove the below parts with tool

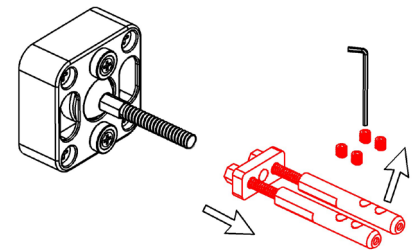

7. Insert the wire rope & lock it tightly

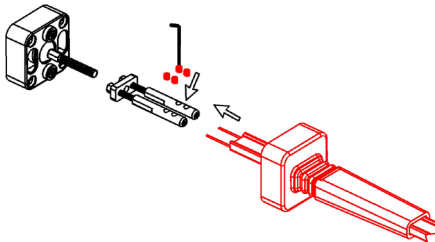

8. Adjust the length of TPV with tool

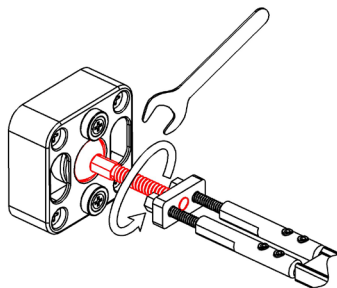

9. Connect the wires with terminals

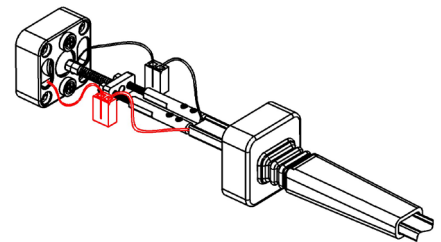

10. Insert the terminals in the canopy

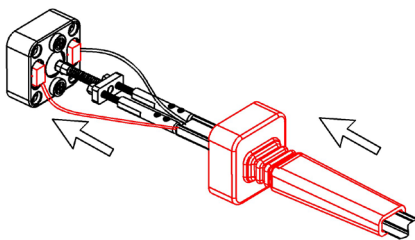

11. Installation completed .

