

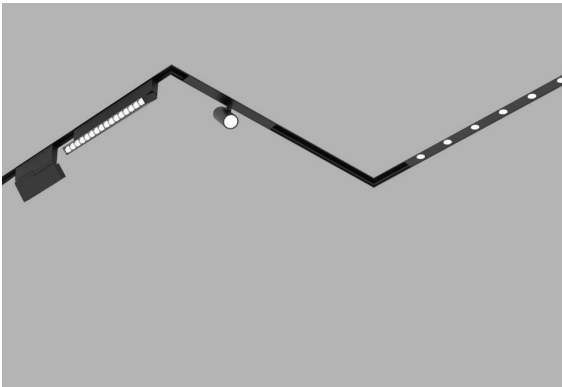

QUE

TRACK LIGHT SYSTEM



The Que Track series presents a collection of track lights that redefine versatility and elegance in lighting solutions. This series offers multiple track types and a wide range of track head, ensuring compatibility with various room styles and configurations. With its sleek design, the Que Track series seamlessly integrates into any space, delivering a modern and sophisticated aesthetic. Its strong features lie in its adaptability, allowing for effortless customization to suit individual preferences. Whether you require a contemporary or traditional ambiance, the Que Track series provides exceptional lighting options that combine functionality with style.

FEATURES

- Various Interchangeable Light Heads Magnetic connection
- Surface, Recessed, Trimless and Pendant application options
- Unlimited finish options
- Seamless link capability
- Maximum 300W connected load per power connection
- Ultra thin silhouette
- 5 Year warranty

PROFILES



Surface



Mud-In Trimless



Non-Mud-In Trimless



Pendant

TRACK HEADS

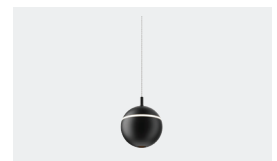



QUE

TRACK LIGHT SYSTEM

TRACK ORDERING GUIDE

Que - _____ - _____ - _____ *Example: Que-SF-6-BK*

Model	Track	Length	Finish
Que	SF Surface	6 6FT	BK Black
	TM Trimless Mud-In	9 9.8FT	WT White
	TN Trimless Non-Mud-In	L L shape	CP Copper
	P Pendant	IL Inner L shape	GD Gold
			BN Brushed Nickel

ACCESSORY ORDERING GUIDE

Que- _____ - _____ *Example: Que-HLC-BK*

Model	Type	Finish
Que	HLC Hard L connector	BK Black
	FLC Flexible L connector	WT White
	SW Starting Wire	CP Copper
	HC Hard Connector	GD Gold
		BN Brushed Nickel

** Accessories are compatible with all 4 track types*



QUE

TRACK LIGHT SYSTEM

SURFACE MOUNT TRACK

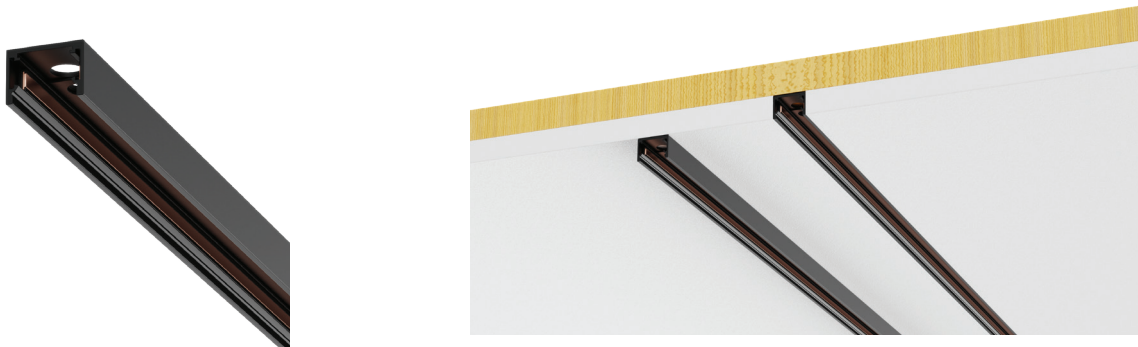

FEATURES

- Unlimited Finish Options
- Seamless link capability
- Maximum 300W connected load per power connection
- Surface or Recessed mount
- Flat L or Inside L shape available
- 6 and 9.6ft lengths
- Tracks are field cuttable at any point

DIMENSIONS

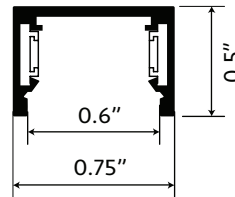

ACCESSORIES



Starting Wire



L Shape Track



Inner L Shape Track

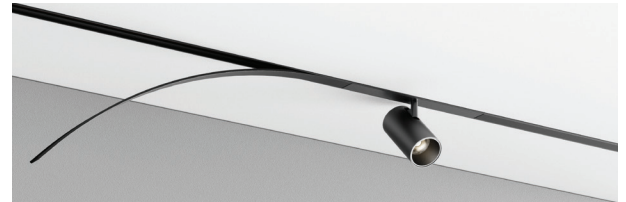

Track Cover (Included with Track)



Hard L Connector



Flexible L connector



Hard connector



QUE

TRACK LIGHT SYSTEM

TRIMLESS MOUNT MUD-IN TRACK

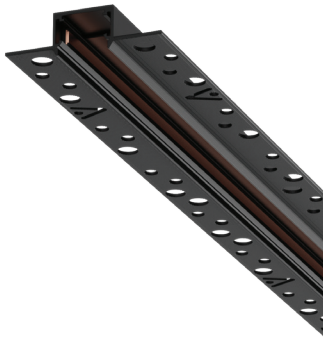

FEATURES

- Unlimited Finish Options
- Seamless link capability
- Maximum 300W connected load per power connection
- Plaster-in recessed mount
- Flat L or Inside L shape available
- 6 and 9.6ft lengths

DIMENSIONS

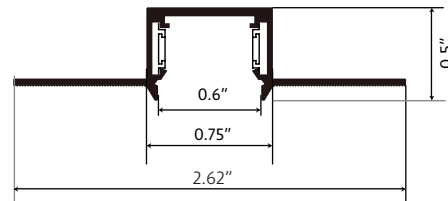

ACCESSORIES



Starting Wire



L Shape Track



Inner L Shape Track



Track Cover (Included with Track)



Hard L Connector



Flexible L connector



Hard connector



QUE

TRACK LIGHT SYSTEM

TRIMLESS MOUNT NON-MUD-IN TRACK



FEATURES

- Unlimited Finish Options
- Seamless link capability
- Maximum 300W connected load per power connection
- Non-plaster-in recessed mount
- Flat L or Inside L shape available
- 6 and 9.6ft lengths

DIMENSIONS

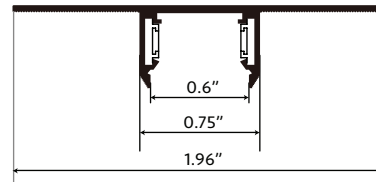

ACCESSORIES



Starting Wire



L Shape Track



Inner L Shape Track



Track Cover (Included with Track)



Hard L Connector



Flexible L connector



Hard connector



QUE

TRACK LIGHT SYSTEM

PENDANT MOUNT TRACK



FEATURES

- Unlimited Finish Options
- Seamless link capability
- Maximum 300W connected load per power connection
- Pendant Mount
- Flat L or Inside L shape available
- 6 and 9.6ft lengths
- 5ft adjustable suspension wire

DIMENSIONS

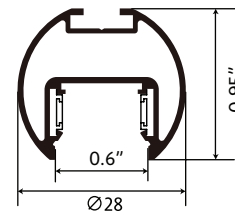

ACCESSORIES



Starting Wire



L Shape Track



Inner L Shape Track



Hard connector

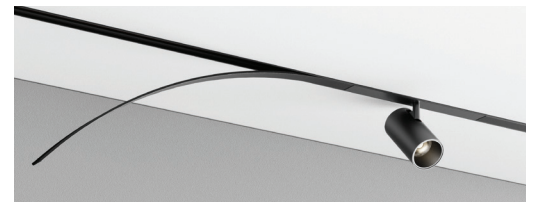

Track Cover (Included with Track)



QUE

TRACK LIGHT SYSTEM

DRIVERS

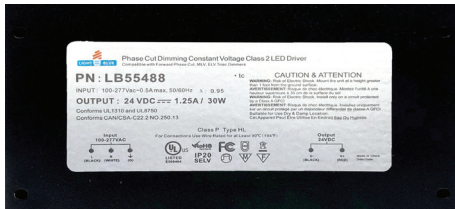

Model LB55488
Wattage 30W
Dimensions 6.5" x 3.6" x 1.02"
Temperature IP20
Dimming Triac

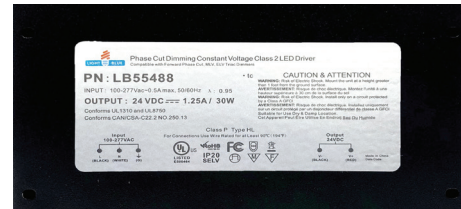

Model LB55470
Wattage 120W
Dimensions 8.66" x 3.6" x 1.61"
Temperature IP20
Dimming Triac



Model LB55489
Wattage 60W
Dimensions 7.4" x 3.6" x 1.02"
Temperature IP20
Dimming Triac

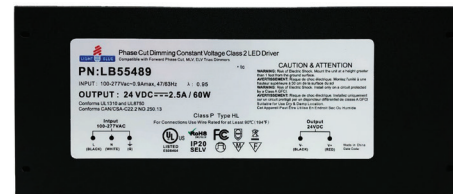

Model LB55471
Wattage 200W
Dimensions 10.23" x 4.05" x 1.81"
Temperature IP20
Dimming Triac

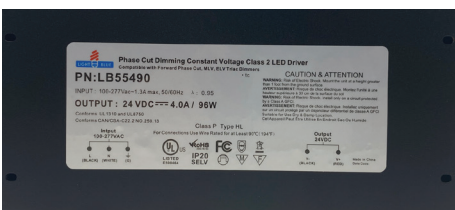

Model LB55490
Wattage 96W
Dimensions 8.66" x 3.6" x 1.61"
Temperature IP20
Dimming Triac

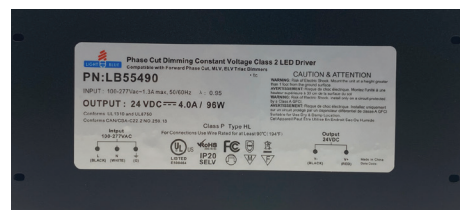

Model LB55472
Wattage 300W
Dimensions 10.94" x 4.25" x 1.81"
Temperature IP20
Dimming Triac



QUE

TRACK LIGHT SYSTEM



SPECIFICATIONS

Power	3W/5W/7W/10W	Material	Aluminum
Input Voltage	24V	Finish	Black/White
CRI	≥90	Dimming	Triac Dimming (Using Triac Dimming Driver)
Temperature	2700K/3000K/3500K/4000K	IP Rating	IP20
Beam Angle	24°/36°/ 45°	Warranty	5 Years
Lumens	270LM/450LM/630LM/900LM		

ORDERING GUIDE

Que14 - _____ - _____ - _____ - _____ - _____ **Example: Que14-3-27-24-HX-BK**

Model	Power	CCT	Beam Angle	Optic Accessories	Finish
Que 14	3 3W	27 2700K	24 24°	HX Hex Louver Lens (Leave blank for no add on)	BK Black WT White
	5 5W	30 3000K	36 36°		
	7 7W	35 3500K	45 45°		
	10 10W	40 4000K			

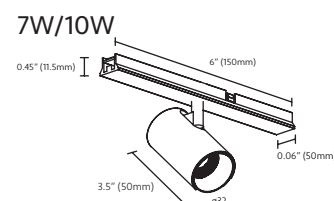
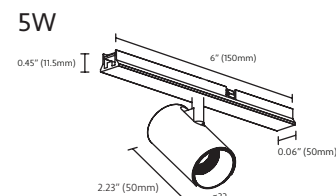
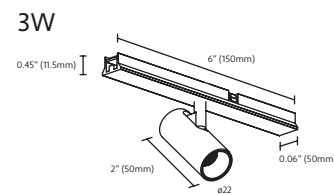



QUE

TRACK LIGHT SYSTEM



SPECIFICATIONS

Power	3W*2/5W*2/7W*2/10W*2	Material	Aluminum
Input Voltage	24V	Finish	Black/White
CRI	≥90	Dimming	Triac Dimming (Using Triac Dimming Driver)
Temperature	2700K/3000K/3500K/4000K	IP Rating	IP20
Beam Angle	24°/36°	Warranty	5 Years
Lumens	540LM/900LM/1260LM/1800LM		

ORDERING GUIDE

Que11 - _____ - _____ - _____ - _____ - _____

Example: Que11 -3-27-24-HX-BK

Model	Power	CCT	Beam Angle	Optic Accessories	Finish
Que 11	3 3W	27 2700K	24 24°	HX Hex Louver Lens (Leave blank for no add on)	BK Black
	5 5W	30 3000K	36 36°		WT White
	7 7W	35 3500K			
	10 10W	40 4000K			

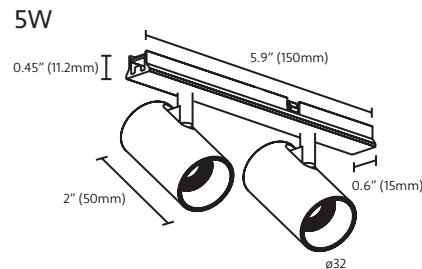
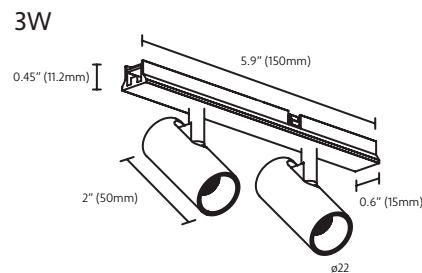



QUE

TRACK LIGHT SYSTEM



SPECIFICATIONS

Power	6W/12W	Material	Aluminum
Input Voltage	24V	Finish	Sand black/White
CRI	≥90	Dimming	Triac Dimming (Using Triac Dimming Driver)
Temperature	2700K/3000K/3500K/4000K	IP Rating	IP20
Beam Angle	36°/ 45°	Warranty	5 Years
Lumens	330LM/660LM		

ORDERING GUIDE

Que13 - _____ - _____ - _____ - _____ **Example: Que13-6-27-36-BK**

Model	Power	CCT	Beam Angle	Finish
Que 13	6 6W	27 2700K	36 36°	BK Black
	12 12W	30 3000K	45 45°	WT White
		35 3500K		
		40 4000K		

6W

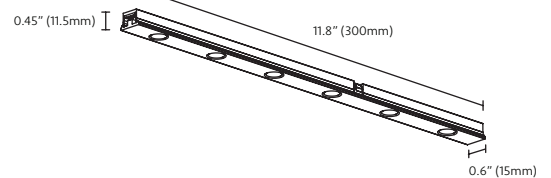

12W

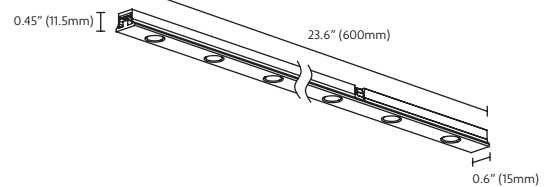



QUE

TRACK LIGHT SYSTEM

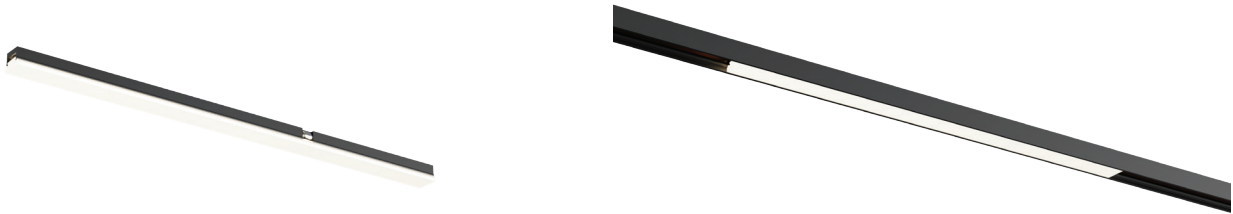

SPECIFICATIONS

Power	6W/12W	Material	Aluminum
Input Voltage	24V	Finish	Sand black/White
CRI	≥90	Dimming	Triac Dimming (Using Triac Dimming Driver)
Temperature	2700K/3000K/3500K/4000K	IP Rating	IP20
Beam Angle	110°	Warranty	5 Years
Lumens	180LM/360LM		

ORDERING GUIDE

Que12 - _____ - _____ - 110 - _____ *Example: Que12-6-27-110-BK*

Model	Power	CCT	Beam Angle	Finish
Que 12	6 6W	27 2700K	110°	BK Black
	12 12W	30 3000K		WT White
		35 3500K		
		40 4000K		

6W

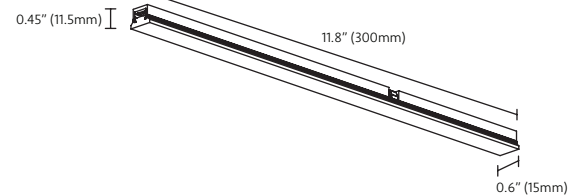

12W

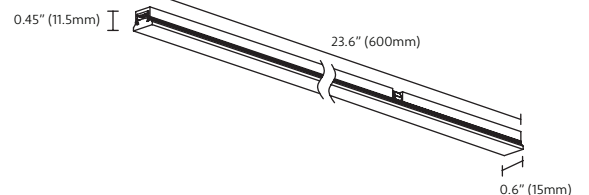



QUE

TRACK LIGHT SYSTEM



SPECIFICATIONS

Power	6W/12W	Lens	Anti-Glare
Input Voltage	24V	Material	Aluminum AL6063
CRI	≥90	Finish	Sand black/ White
Temperature	2700K/3000K/3500K/4000K	Dimming	Triac Dimming (Using Triac Dimming Driver)
Beam Angle	36°/45°	IP Rating	IP20
Lumens	408LM/816LM	Warranty	5 Years

ORDERING GUIDE

Que10 - _____ - _____ - _____ - _____ **Example: Que10-6-27-36-BK**

Model	Power	CCT	Beam Angle	Finish
Que 10	6 6W	27 2700K	36 36°	BK Black
	12 12W	30 3000K	45 45°	WT White
		35 3500K		
		40 4000K		

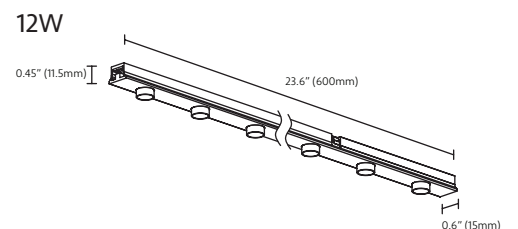
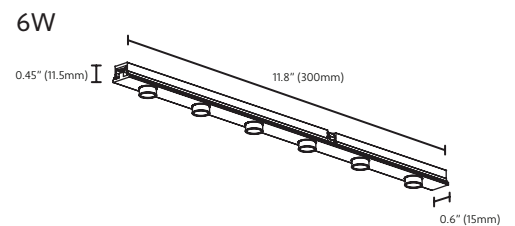



QUE

TRACK LIGHT SYSTEM

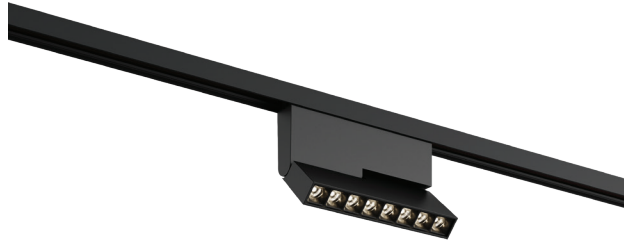

SPECIFICATIONS

Power	8W/16W	Lens	Anti-Glare
Input Voltage	24V	Material	Aluminum
CRI	90	Finish	Black/White
Temperature	2700K/3000K/3500K/4000K	Dimming	Triac Dimming (Using Triac Dimming Driver)
Beam Angle	24°/36°/ 45°	IP Rating	IP20
Lumens	640LM/1280LM	Warranty	5 Years

ORDERING GUIDE

Que16 - _____ - _____ - _____ - _____ *Example: Que16-8-27-24-BK*

Model	Power	CCT	Beam Angle	Finish
Que 16	8 8W	27 2700K	24 24°	BK Black
	16 16W	30 3000K	36 36°	WT White
		35 3500K	45 45°	
		40 4000K		

8W

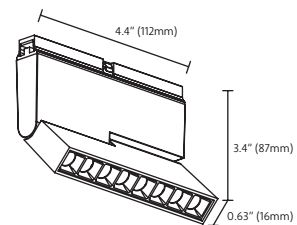

16W

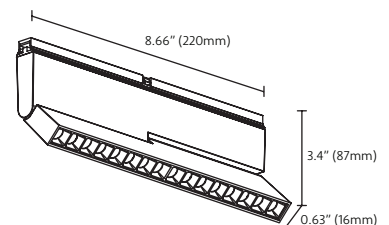



QUE

TRACK LIGHT SYSTEM



SPECIFICATIONS

Power	8W/16W	Lens	Anti-Glare
Input Voltage	24V	Material	Aluminum
CRI	90	Finish	Black/White
Temperature	2700K/3000K/3500K/4000K	Dimming	Triac Dimming (Using Triac Dimming Driver)
Beam Angle	24°/45°	IP Rating	IP20
Lumens	640LM/1280LM	Warranty	5 Years

ORDERING GUIDE

Que17 - _____ - _____ - _____ - _____ **Example: Que17-8-27-24-BK**

Model	Power	CCT	Beam Angle	Finish
Que 17	8 8W	27 2700K	24 24°	BK Black
	16 16W	30 3000K	45 45°	WT White
		35 3500K		
		40 4000K		

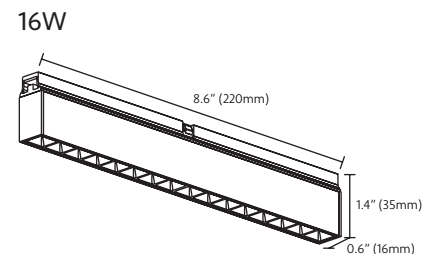
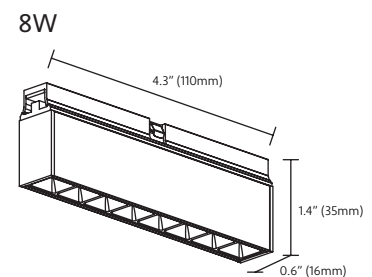



QUE

TRACK LIGHT SYSTEM



SPECIFICATIONS

Power	8W	Cord Length	220mm
Input Voltage	24V	Material	Aluminum
Lumens	425LM	Finish	Blake/White
CRI	≥90	Dimming	Triac Dimming (Using Traic Dimming Driver)
Temperature	2700K/3000K/3500K/4000K	Rating	IP20
Beam Angle	15°/24°/45°	Warranty	5 Years

ORDERING GUIDE

Que 15 - 8 - _____ - _____ - _____ *Example: Que15-8-27-15-BK*

Model	Power	CCT	Beam Angle	Finish
Que 15	8 8W	27 2700K	15 15°	BK Black
		30 3000K	24 24°	WT White
		35 3500K	45 45°	
		40 4000K		

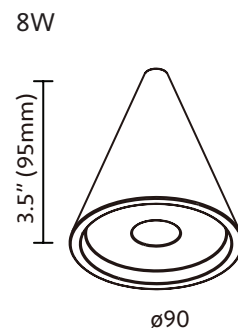



QUE

TRACK LIGHT SYSTEM

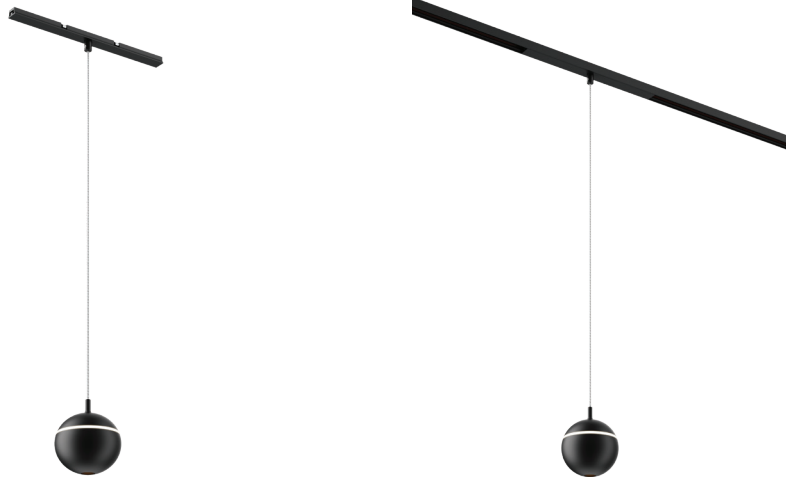

SPECIFICATIONS

Power	6W	Material	Aluminum
Input Voltage	24V	Finish	Black/White
CRI	90	Dimming	Triac Dimming (Using Traic Dimming Driver)
Temperature	2700K/3000K/3500K/4000K	IP Rating	IP20
Beam Angle	24°/40°	Warranty	5 Years
Lumens	352LM		

ORDERING GUIDE

Que18 - 6 - _____ - _____ - _____ *Example: Que18-6-27-24-BK*

Model	Power	CCT	Beam Angle	Finish
Que 18	6 6W	27 2700K	24 24°	BK Black
		30 3000K	40 40°	WT White
		35 3500K		
		40 4000K		

6W

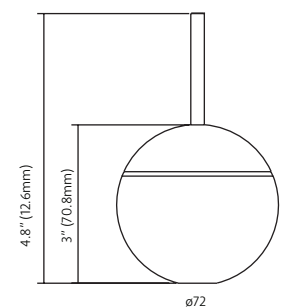



QUE

TRACK LIGHT SYSTEM



SPECIFICATIONS

Power	5W	Material	Aluminum
Input Voltage	24V	Finish	Black/White
CRI	90	Dimming	Triac Dimming (Using Triac Dimming Driver)
Temperature	2700K/3000K/3500K/4000K	IP Rating	IP20
Beam Angle	330°	Warranty	5 Years
Lumens	506LM		

ORDERING GUIDE

Que19 - 5 - _____ - 330 - _____ *Example: Que19-5-27-330-BK*

Model	Power	CCT	Beam Angle	Finish
Que 19	5 5W	27 2700K	330°	BK Black WT White
		30 3000K		
		35 3500K		
		40 4000K		

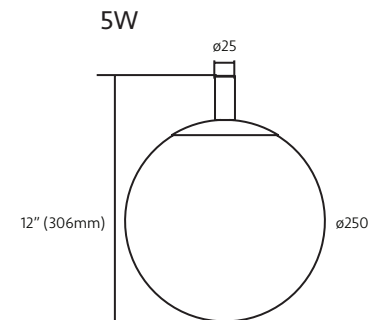



QUE

TRACK LIGHT SYSTEM



SPECIFICATIONS

Power	3W	Material	Aluminum
Input Voltage	24V	Finish	Sand black/White
CRI	≥90	Dimming	Triac Dimming (Using Triac Dimming Driver)
Temperature	2700K/3000K/3500K/4000K	IP Rating	IP20
Beam Angle	360°	Warranty	5 Years
Lumens	220LM		

ORDERING GUIDE

Que20 - ____ -3- ____ - 360 - ____

Example: Que20-F-3-27-360-BK

Model	Mounting	Power	CCT	Beam Angle	Finish
Que 20	F Flush P Pendant	3W	27 2700K	360°	BK Black WT White
			30 3000K		
			35 3500K		
			40 4000K		

3W

