

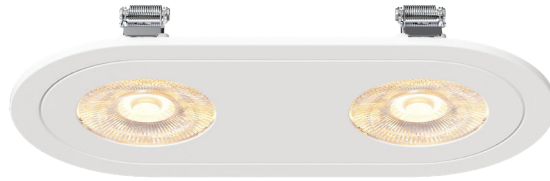

LUCID

ROUND DOUBLE DIAMOND LENS



FEATURES

- Ultra slim 1.25" height
- Interchangeable trim rings
- Universal voltage
- 5 CCT selectable

SPECIFICATIONS

Wattage	2 x 10W / 2 x 15W	Efficacy	78LM/W
Lumens (Delivered)	1980LM	Environment	Damp Location
Input Voltage	120-277V	Material	Aluminum
CCT	27K/30K/35K/40K/50K/ 5 CCT SELECT	Operating Temperature	-25°C - 40°C
CRI	90	Certification	ETL
Beam Angle	15° / 24° / 36° / 50°	Cut Out	10" W x 5" H
Dimming	Triac & 0-10V		

ORDERING GUIDE

LCD - RDD - LS - _____ - _____ - UNV - _____ - _____ - _____ - _____

Example: LCD-RDD-10-27-UNV-15-WT-SB-RD-EM

Model	Wattage	Lumens	Color Temperature	Input Voltage	Beam Angle	Trim Finish
LCD-RDD-LS	10 2x10W	1980LM	27 2700K	UNV 120-277V	15 15°	WT White
	15 2x15W		30 3000K		24 24°	BK Black
			35 3500K		36 36°	BN Brushed Nickel
			40 4000K		50 50°	BZ Bronze
			50 5000K			CP Copper
			5CCT 5CCT Selectable			
Installation	Trim Shape	EM				
Recessed (Leave Blank)	RD Round SQ Square	EM				
SB Surface box						

* NCH-LCD26 - New Construction Plate



LUCID ROUND DOUBLE DIAMOND LENS

DIMENSION

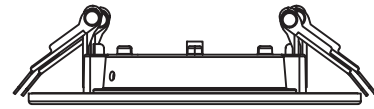
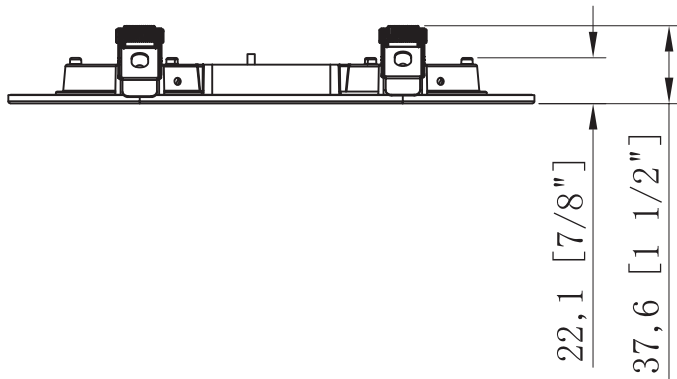
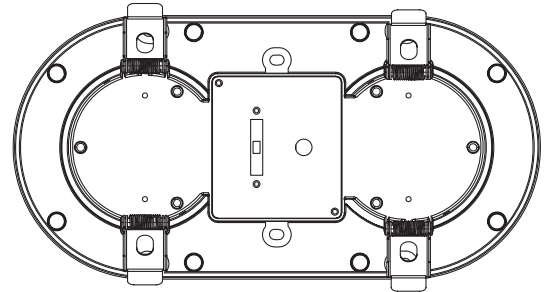
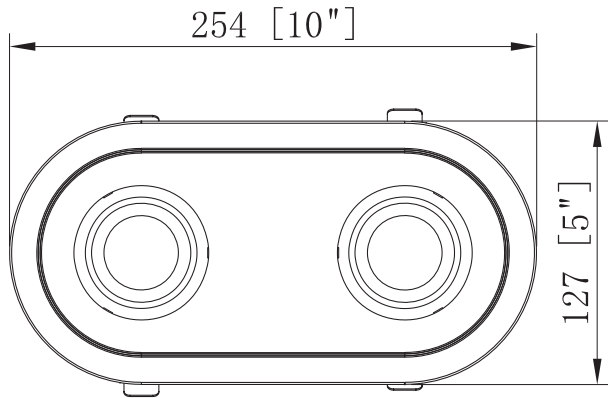



LUCID

ROUND DOUBLE DIAMOND LENS

ACCESSORIES

Surface Box

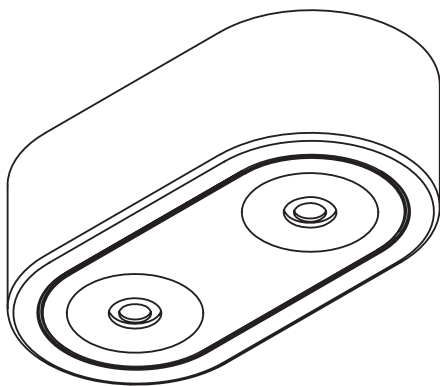
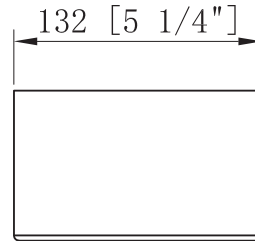
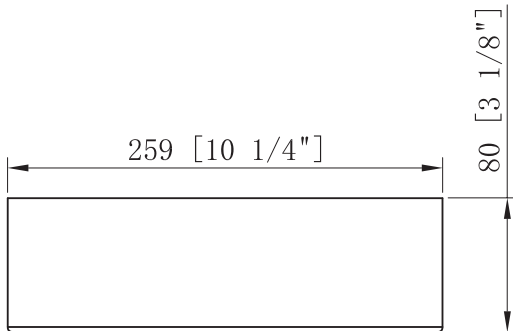
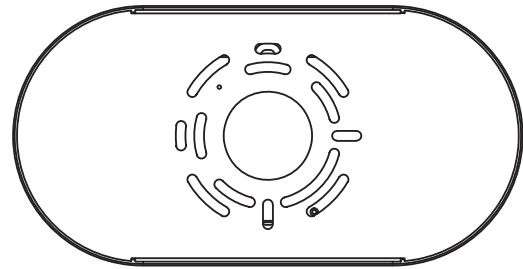
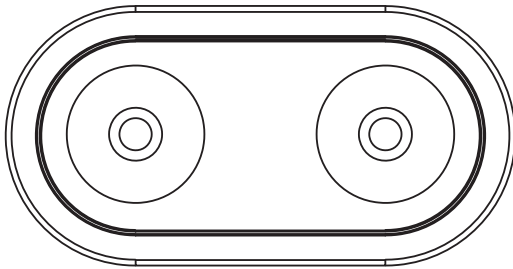



LUCID ROUND DOUBLE DIAMOND LENS

NEW CONSTRUCTION PLATE

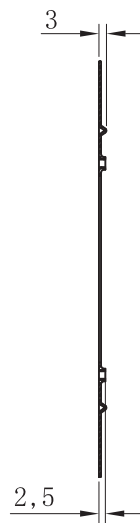
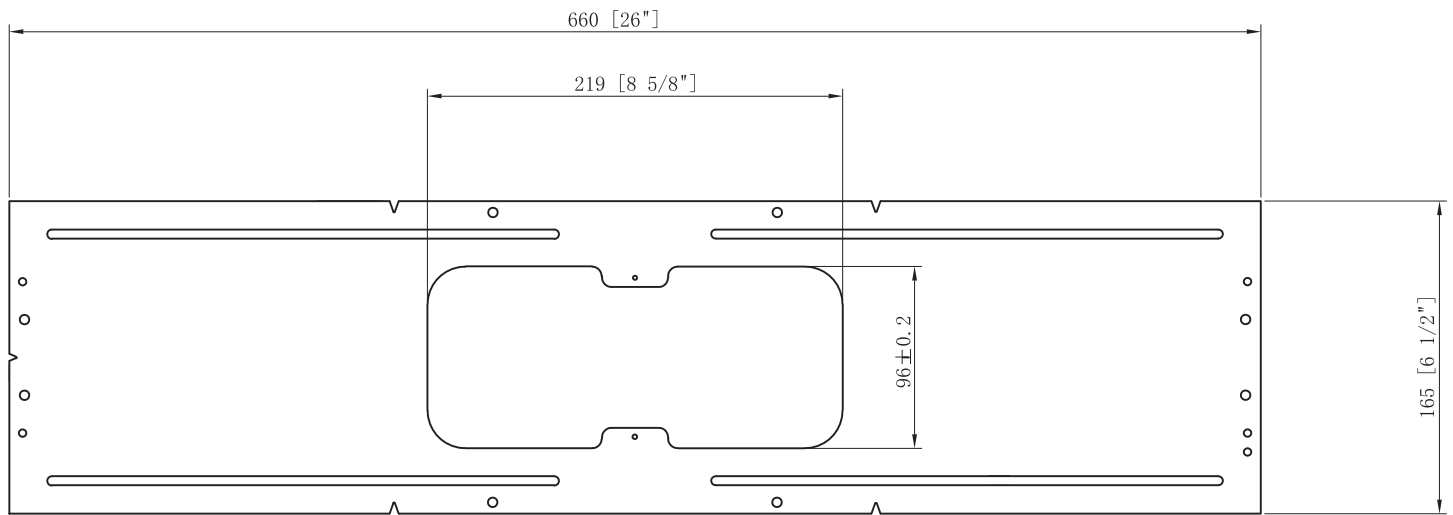



LUCID ROUND DOUBLE DIAMOND LENS

TRIM OPTIONS

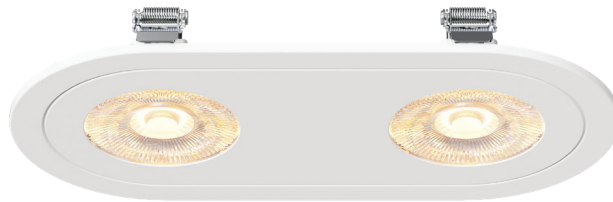

Round

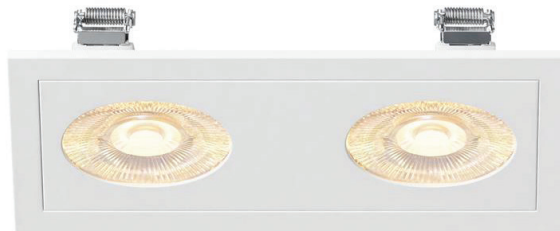

Square



LUCID ROUND DOUBLE DIAMOND LENS

EMERGENCY BACK UP DRIVER RAD25/35-EM

90 minute run time
See spec sheet for for further information

