

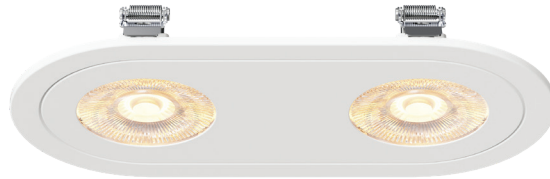

ROUND DOUBLE DIAMOND LENS

LCD

RECESSED LED DOWNLIGHT



FEATURES

- Ultra slim 1.25" height
- Interchangeable trim rings
- Universal voltage
- 5 CCT selectable

SPECIFICATIONS

Wattage	2 x 10W / 2 x 15W	Efficacy	78LM/W
Lumens (Delivered)	1980LM	Environment	Damp Location
Input Voltage	120-277V	Material	Aluminum
CCT	27K/30K/35K/40K/50K/ 5 CCT SELECT	Operating Temperature	-25°C - 40°C
CRI	90	Certification	ETL
Beam Angle	15° / 24° / 36° / 50°	Cut Out	10" W x 5" H
Dimming	Triac & 0-10V		

ORDERING GUIDE

LCD - RDD - LS - _____ - _____ - UNV - _____ - _____ - _____ - _____ *Example: LCD-RDD-10-27-UNV-15-WT-SB-RD*

Model	Wattage	Lumens	Color Temperature	Input Voltage	Beam Angle	Trim Finish
LCD-RDD-LS	10 2x10W 15 2x15W	1980LM	27 2700K 30 3000K 35 3500K 40 4000K 50 5000K 5CCT 5CCT Selectable	UNV 120-277V	15 15° 24 24° 36 36° 50 50°	WT White BK Black BN Brushed Nickel BZ Bronze CP Copper
Installation	Trim Shape					
Recessed (Leave Blank)	RD Round SQ Square					
SB Surface box		* NCH-LCD - New Construction Plate				



LCD ROUND DOUBLE DIAMOND LENS

RECESSED LED DOWNLIGHT

DIMENSION

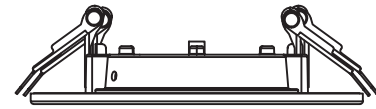
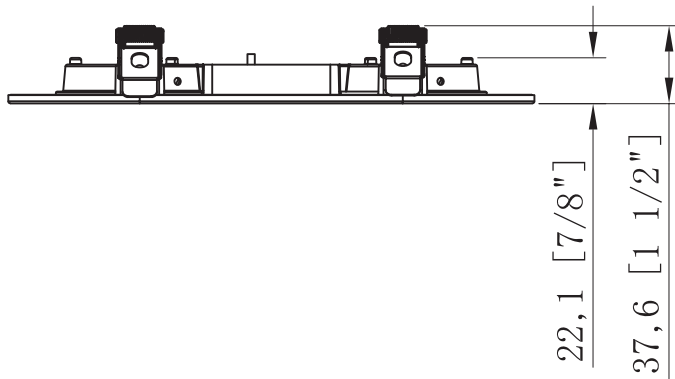
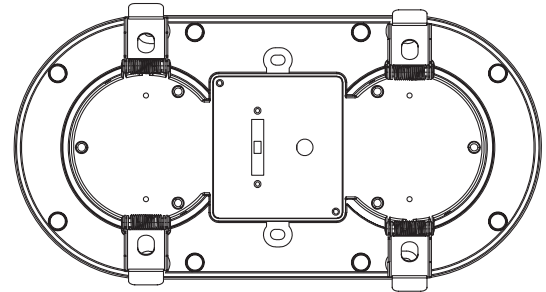
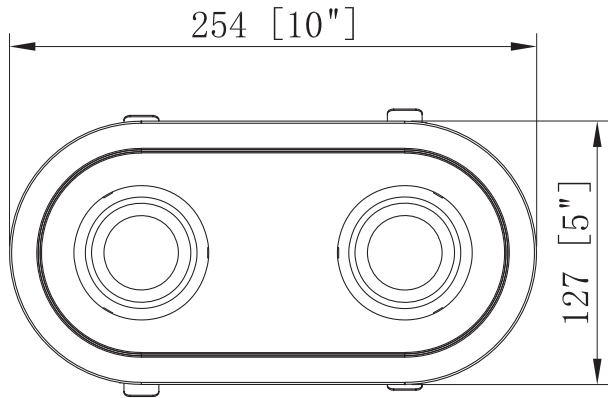



ROUND DOUBLE DIAMOND LENS

LCD

RECESSED LED DOWNLIGHT

ACCESSORIES

Surface Box

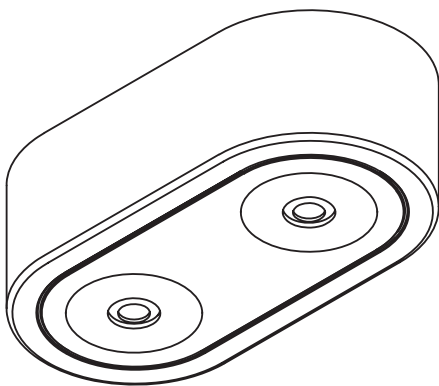
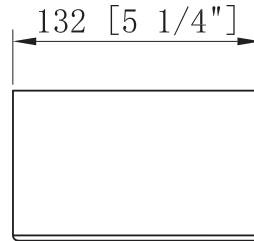
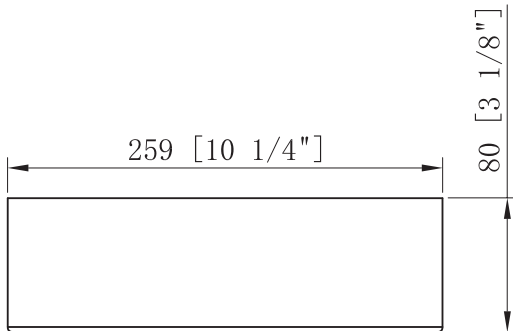
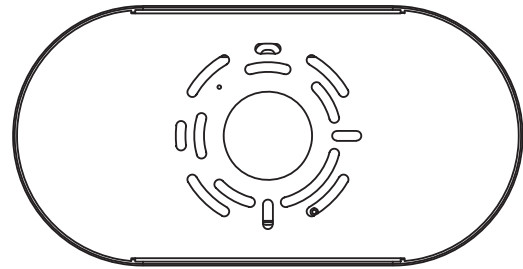
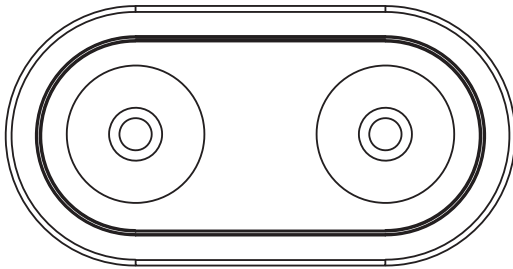



LCD ROUND DOUBLE DIAMOND LENS

RECESSED LED DOWNLIGHT

NEW CONSTRUCTION PLATE

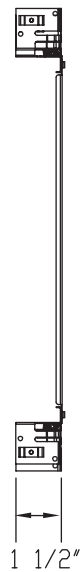
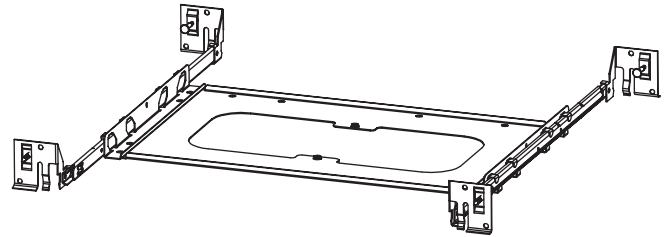
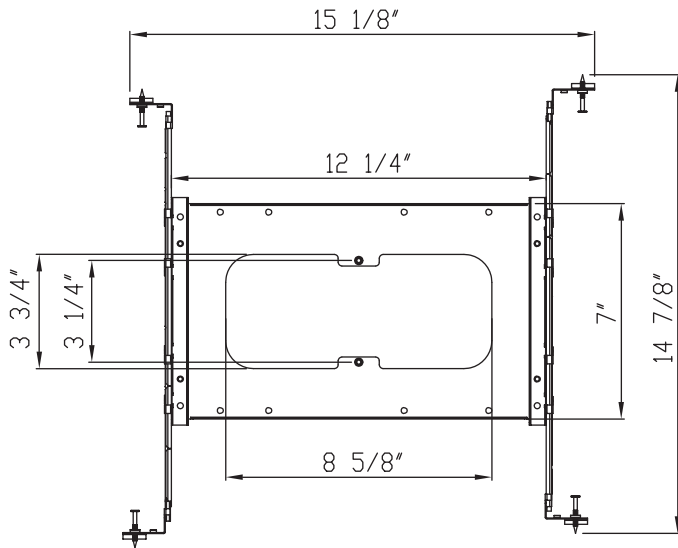



LCD ROUND DOUBLE DIAMOND LENS

RECESSED LED DOWNLIGHT

TRIM OPTIONS

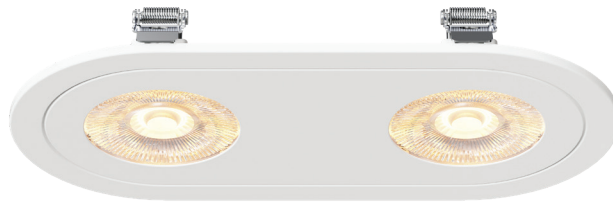

Round

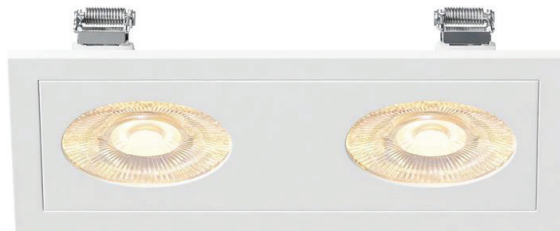

Square