



# RYNO 3.0 MILLWORK

3" RECESSED LED DOWNLIGHT



## FEATURES

- Selectable wattage (9W / 12W / 15W) with high-efficacy output for flexible performance across applications.
- Precision optics available in 8°, 15°, 24°, 36°, and 50° beam spreads for controlled illumination.
- Universal voltage (120–277V) with Triac/0-10V dimming from 1–100% for smooth control.
- Compact 3" aperture with trimmed, trimless mud-in, millwork, adjustable, and wallwash configurations for seamless integration.
- Type IC rated - approved for direct contact with insulation.

## PERFORMANCE

Wattage	9W/12W/15W Selectable
Lumens (Delivered)	Up to 117LM/W
Input Voltage	120-277V
Dimming	Triac, 0-10V (1%-100%)
Lifetime	50,000 hrs

## MEDIA

Hex Louver  
Solite

## APPLICATION

Environment	Wet Location
Material	Aluminum
Operating Temperature	-49° F to 113° F
Lamp Life	5 Years
Cut Out	3.25"

## LIGHT SOURCE

CCT	2700K/3000K/3500K/4000K/Dim to Warm
CRI	90

## OPTICS

Lens / Reflector	8° / 15° / 24° / 36° / 50°
------------------	----------------------------

## CERTIFICATION

IC Rated  
ETL  
CETL  
Title 24  
FCC

## SUPPORTIVE FILE (WEBSITE LINK)

[IES File](#)  
[Installation Guide](#)  
[Trimmed Configuration](#)  
[Trimless Mud-In Configuration](#)  
[Wallwash Configuration](#)  
[Adjustable Trimmed Configuration](#)  
[Adjustable Trimless Mud-In Configuration](#)  
[Adjustable Millwork Configuration](#)



# RYNO 3.0 MILLWORK







3" RECESSED LED DOWNLIGHT

## ORDERING GUIDE

RYN23- \_\_\_\_\_ - \_\_\_\_\_ - \_\_\_\_\_ - \_\_\_\_\_ - \_\_\_\_\_

Example: RYN23-2790-15-L-HX-3MLWR-WT

\*\* New Construction Plate is an individual part number NCH-RYN23

Component	Component Code	Component Detail
 <p>ENGINE</p>	<b>RYN23</b>	9W/12W/15W Engine
 <p>CHIP</p>	<b>2790</b> <b>3090</b> <b>3590</b> <b>4090</b> <b>DTW</b> <b>2090-8L</b> <b>3090-8L</b> <b>3590-8L</b> <b>4090-8L</b> <b>DTW-8L</b>	2700K, 90CRI 3000K, 90CRI 3500K, 90CRI 4000K, 90CRI 1800-3000K Dim to Warm, 98CRI 2700K, 90CRI 8 Degree Narrow 3000K, 90CRI 8 Degree Narrow 3500K, 90CRI 8 Degree Narrow 4000K, 90CRI 8 Degree Narrow Dim to Warm, 98CRI 8 Degree Narrow
 <p>Reflector      Lens</p> <p>OPTIC</p>	<b>8</b> <b>15</b> <b>L</b> <b>24</b> <b>36</b> <b>R</b> <b>50</b>	8 Degree ** For use with 8 degree chip only 15 Degree 24 Degree 36 Degree 50 Degree
 <p>Solite      Hex Louver</p> <p>MEDIA</p>	<b>HX</b> <b>SL</b>	Hex Louver Solite  (Leave blank for none) (SL-HX for both)
 <p>TRIM</p>	<b>3MLWR-WT</b> <b>3MLWR-BK</b>	Round Millwork Trim, White Finish Round Millwork Trim, Black Finish
	<b>NCH-RYN23</b>	New Construction Plate **Individual part number from downlight



# RYNO 3.0 MILLWORK

3" RECESSED LED DOWNLIGHT

## DIMENSIONS

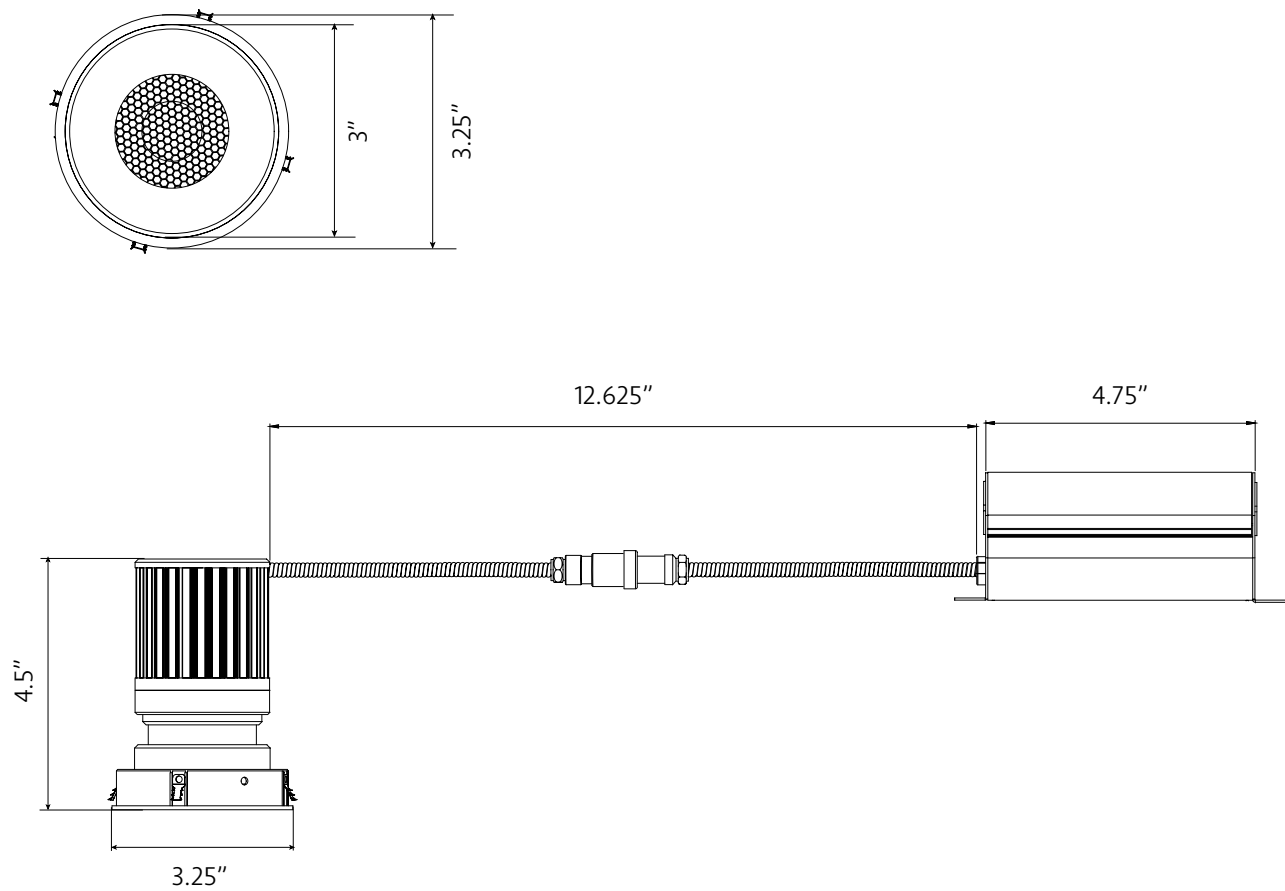



# RYNO 3.0 MILLWORK

3" RECESSED LED DOWNLIGHT

## DELIVERED LUMENS MATRIX

90CRI, Lens Optic, White Trim

Wattage	Color Temperature	15° Optic	24° Optic	36° Optic	50° Optic
9W	2700K (90CRI)	1023.9	1072.2	1016.2	966
	3000K (90CRI)	957.4	996.08	952.72	925.7
	3500K (90CRI)	1073.86	1013	1006.22	999.02
	4000K (90CRI)	1101.06	1150.49	1093.15	1028.06
	Dim to Warm (98CRI)	702.99	720.2	684.69	662.4
	Hex Louver (3000K)	771.7	744.24	722.72	646.01
	Solite (3000K)	912.8	931.22	899.57	869.68
12W	2700K (90CRI)	1347.2	1423.7	1417.5	1397.7
	3000K (90CRI)	1453	1334.6	1354.5	1297.9
	3500K (90CRI)	1369.6	1406.3	1428.3	1356
	4000K (90CRI)	1401.9	1453.3	1451	1403.6
	Dim to Warm (98CRI)	1057.5	1075.3	1062.2	1051.4
	Hex Louver (3000K)	1068.2	1100.5	1073.3	863.4
	Solite (3000K)	1352.3	1383.7	1402.5	1335.5
15W	2700K (90CRI)	1537.5	1594.8	1588	1519.5
	3000K (90CRI)	1635.1	1658.6	1688.9	1610.7
	3500K (90CRI)	1699.6	1731	1754.5	1700.1
	4000K (90CRI)	1760	1890.7	1790.9	1741.7
	Dim to Warm (98CRI)	1368.3	1370.7	1383.2	1334
	Hex Louver (3000K)	1198.9	1213.6	1198.7	1068.8
	Solite (3000K)	1508	1566.1	1587.3	1491.2



# RYNO 3.0 MILLWORK

## 3" RECESSED LED DOWNLIGHT

### LUMINOUS INTENSITY DISTRIBUTION DIAGRAM

9W

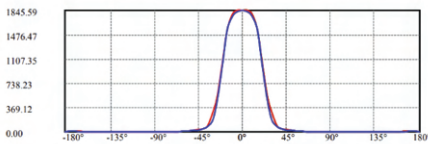
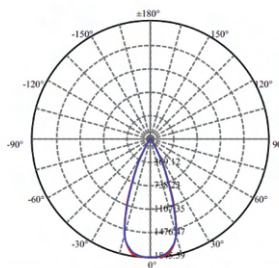

C0(Max): —  
 C0/C180: —  
 C90/C270: —  
 Field angle(10%Imax):C0/180Left:37.8 Right:27.8  
                                   :C90/270Left:30.1 Right:30.1  
 Beam Angle(50%Imax):C0/180Left:26.5 Right:16.5  
                                   :C90/270Left:21.2 Right:21.2

12W

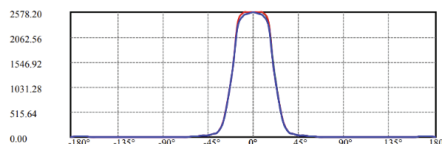
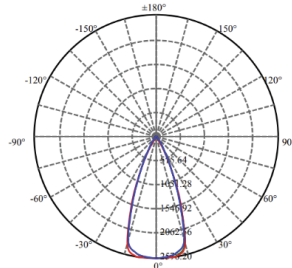

C15(Max): —  
 C0/C180: —  
 C90/C270: —  
 Field angle(10%Imax):C0/180Left:31.0 Right:31.0  
                                   :C90/270Left:30.9 Right:30.9  
 Beam Angle(50%Imax):C0/180Left:21.2 Right:21.2  
                                   :C90/270Left:21.2 Right:21.2

15W

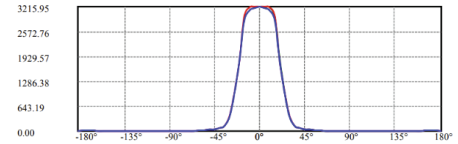
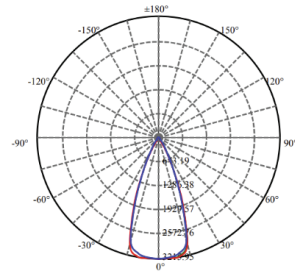

C15(Max): —  
 C0/C180: —  
 C90/C270: —  
 Field angle(10%Imax):C0/180Left:31.0 Right:31.0  
                                   :C90/270Left:30.9 Right:30.9  
 Beam Angle(50%Imax):C0/180Left:21.2 Right:21.2  
                                   :C90/270Left:21.2 Right:21.2



# RYNO 3.0 MILLWORK

3" RECESSED LED DOWNLIGHT

## NEW CONSTRUCTION MOUNTING PLATE NCH-RYN23

- Constructed out of galvanized steel

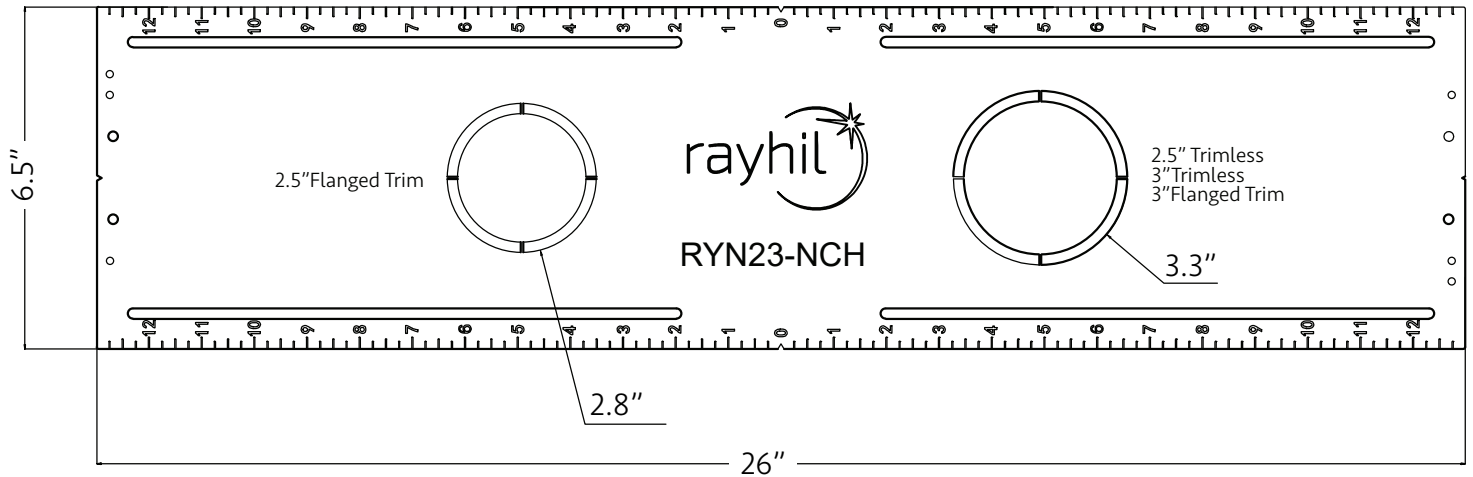



# RYNO 3.0 MILLWORK

3" RECESSED LED DOWNLIGHT

## COMPATIBLE DRIVERS

<b>LUTRON</b>	<b>LOAD (W)</b>
LUTRON MC3J2	300W
LUTRON AYCL-153P	150W
LUTRON SCL-153P	150W
LUTRON DVCL-153P	150W
LUTRON DVSTV-453P	450W

<b>LEVITON</b>	<b>LOAD (W)</b>
LEVITON IPL06	300W
LEVITON 6672	300W
LEVITON 6674	150W
LEVITON DSM10	450W
LEVITON IP710	—

<b>LEGRAND</b>	<b>LOAD (W)</b>
LEGRAND/PS RHCL453P	450W