



RYNO 3.0

3" RECESSED LED DOWNLIGHT



FEATURES

- Selectable wattage (9W / 12W / 15W) with high-efficacy output for flexible performance across applications.
- Precision optics available in 8°, 15°, 24°, 36°, and 50° beam spreads for controlled illumination.
- Universal voltage (120–277V) with Triac/0-10V dimming from 1–100% for smooth control.
- Compact 3" aperture with trimmed, trimless mud-in, millwork, adjustable, and wallwash configurations for seamless integration.

PERFORMANCE

Wattage	9W/12W/15W Selectable
Lumens (Delivered)	Up to 117LM/W
Input Voltage	120-277V
Dimming	Triac, 0-10V (1%-100%)
Lifetime	50,000 hrs

LIGHT SOURCE

CCT	2700K/3000K/3500K/4000K/Dim to Warm
CRI	90

OPTICS

Lens / Reflector	8° / 15° / 24° / 36° / 50°
------------------	----------------------------

MEDIA

Hex Louver
Solite

CERTIFICATION

ETL
CETL
Title 24
FCC

APPLICATION

Environment	Wet Location
Material	Aluminum
Operating Temperature	-49° F to 113° F
Lamp Life	5 Years
Cut Out	3.3"

SUPPORTIVE FILE (WEBSITE LINK)

[IES File](#)
[Installation Guide](#)
[Trimless Mud-In Configuration](#)
[Millwork Configuration](#)
[Wallwash Configuration](#)
[Adjustable Trimmed Configuration](#)
[Adjustable Trimless Mud-In Configuration](#)
[Adjustable Millwork Configuration](#)









RYNO 3.0

3" RECESSED LED DOWNLIGHT

ORDERING GUIDE

RYN23- _____ - _____ - _____ - _____ - _____

Example: RYN23-2790-15-L-HX-3RDWT ** New Construction Plate is an individual part number NCH-RYN23

Component	Component Code	Component Detail
 <p>ENGINE</p>	RYN23	9W/12W/15W Engine
 <p>CHIP</p>	2790 3090 3590 4090 DTW 2090-8L 3090-8L 3590-8L 4090-8L DTW-8L	2700K, 90CRI 3000K, 90CRI 3500K, 90CRI 4000K, 90CRI 1800-3000K Dim to Warm, 98CRI 2700K, 90CRI 8 Degree Narrow 3000K, 90CRI 8 Degree Narrow 3500K, 90CRI 8 Degree Narrow 4000K, 90CRI 8 Degree Narrow Dim to Warm, 98CRI 8 Degree Narrow
 <p>Reflector Lens</p> <p>OPTIC</p>	8 15 L 24 36 R 50	8 Degree ** For use with 8 degree chip only 15 Degree 24 Degree 36 Degree 50 Degree
 <p>Solite Hex Louver</p> <p>MEDIA</p>	HX SL	Hex Louver Solite (Leave blank for none) (SL-HX for both)
 <p>TRIM</p>	3RDWT 3RDBK 3SQWT 3SQBK 3WLSH	Round Flange Trim, White Finish Round Flange Trim, Black Finish Square Flange Trim, White Finish Square Flange Trim, Black Finish Round Flange Wallwash Trim, White Finish
	NCH-RYN23	New Construction Plate **Individual part number from downlight



RYNO 3.0

3" RECESSED LED DOWNLIGHT

DIMENSIONS

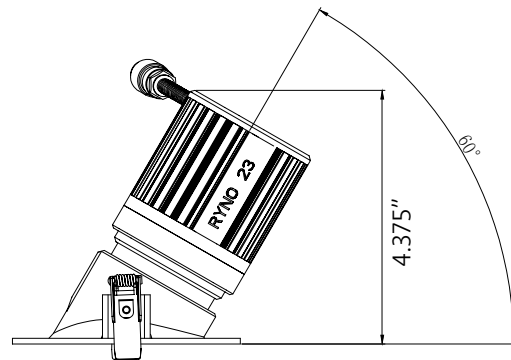
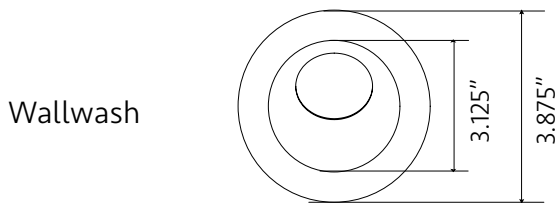
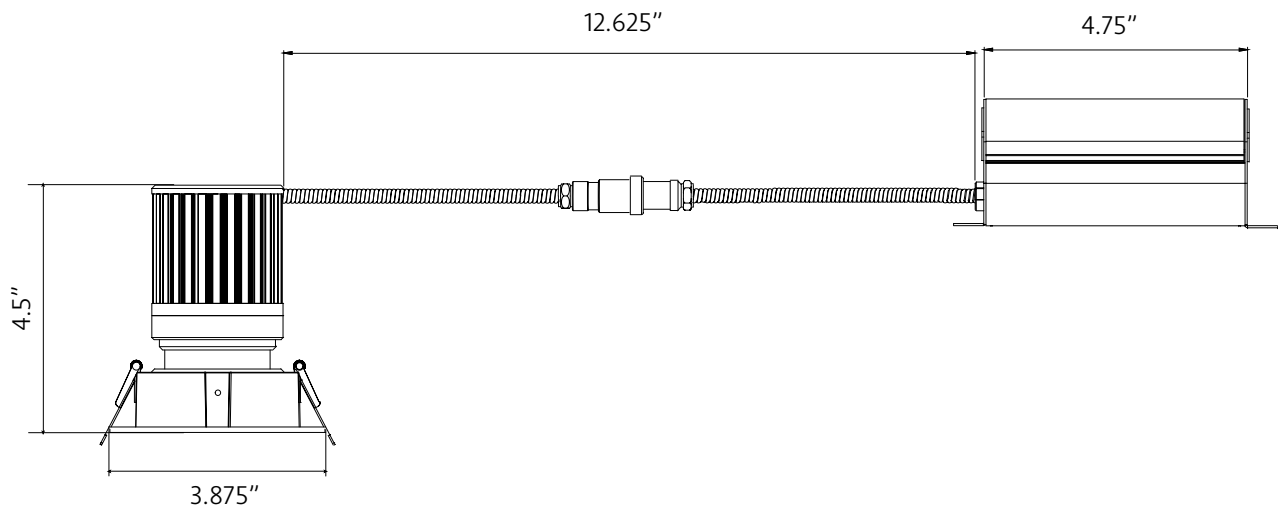
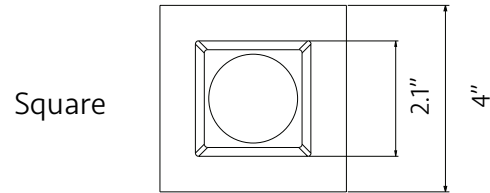
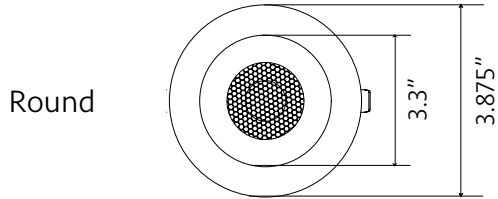



RYNO 3.0

3" RECESSED LED DOWNLIGHT

DELIVERED LUMENS MATRIX

90CRI, Lens Optic, White Trim

Wattage	Color Temperature	15° Optic	24° Optic	36° Optic	50° Optic
9W	2700K (90CRI)	1023.9	1072.2	1016.2	966
	3000K (90CRI)	957.4	996.08	952.72	925.7
	3500K (90CRI)	1073.86	1013	1006.22	999.02
	4000K (90CRI)	1101.06	1150.49	1093.15	1028.06
	Dim to Warm (98CRI)	702.99	720.2	684.69	662.4
	Hex Louver (3000K)	771.7	744.24	722.72	646.01
	Solite (3000K)	912.8	931.22	899.57	869.68
12W	2700K (90CRI)	1347.2	1423.7	1417.5	1397.7
	3000K (90CRI)	1453	1334.6	1354.5	1297.9
	3500K (90CRI)	1369.6	1406.3	1428.3	1356
	4000K (90CRI)	1401.9	1453.3	1451	1403.6
	Dim to Warm (98CRI)	1057.5	1075.3	1062.2	1051.4
	Hex Louver (3000K)	1068.2	1100.5	1073.3	863.4
	Solite (3000K)	1352.3	1383.7	1402.5	1335.5
15W	2700K (90CRI)	1537.5	1594.8	1588	1519.5
	3000K (90CRI)	1635.1	1658.6	1688.9	1610.7
	3500K (90CRI)	1699.6	1731	1754.5	1700.1
	4000K (90CRI)	1760	1890.7	1790.9	1741.7
	Dim to Warm (98CRI)	1368.3	1370.7	1383.2	1334
	Hex Louver (3000K)	1198.9	1213.6	1198.7	1068.8
	Solite (3000K)	1508	1566.1	1587.3	1491.2



RYNO 3.0

3" RECESSED LED DOWNLIGHT

LUMINOUS INTENSITY DISTRIBUTION DIAGRAM

9W

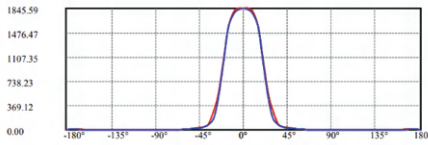
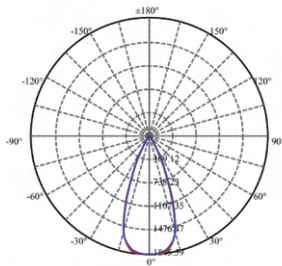

C0(Max): —
 C0/C180: —
 C90/C270: —
 Field angle(10%Imax):C0/180Left:37.8 Right:27.8
 :C90/270Left:30.1 Right:30.1
 Beam Angle(50%Imax):C0/180Left:26.5 Right:16.5
 :C90/270Left:21.2 Right:21.2

12W

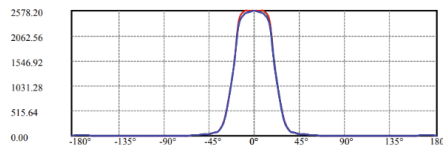
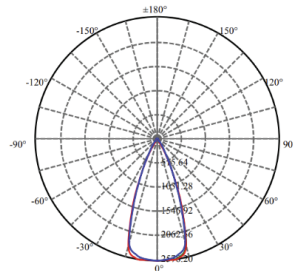

C15(Max): —
 C0/C180: —
 C90/C270: —
 Field angle(10%Imax):C0/180Left:31.0 Right:31.0
 :C90/270Left:30.9 Right:30.9
 Beam Angle(50%Imax):C0/180Left:21.2 Right:21.2
 :C90/270Left:21.2 Right:21.2

15W

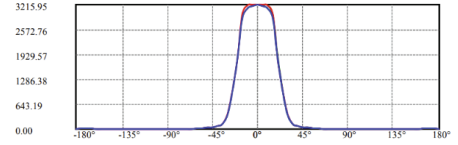
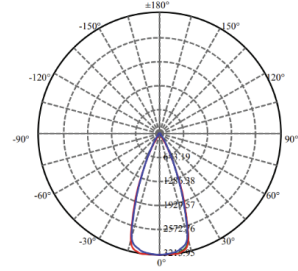

C15(Max): —
 C0/C180: —
 C90/C270: —
 Field angle(10%Imax):C0/180Left:31.0 Right:31.0
 :C90/270Left:30.9 Right:30.9
 Beam Angle(50%Imax):C0/180Left:21.2 Right:21.2
 :C90/270Left:21.2 Right:21.2



RYNO 3.0

3" RECESSED LED DOWNLIGHT

NEW CONSTRUCTION MOUNTING PLATE NCH-RYN23

- Constructed out of galvanized steel

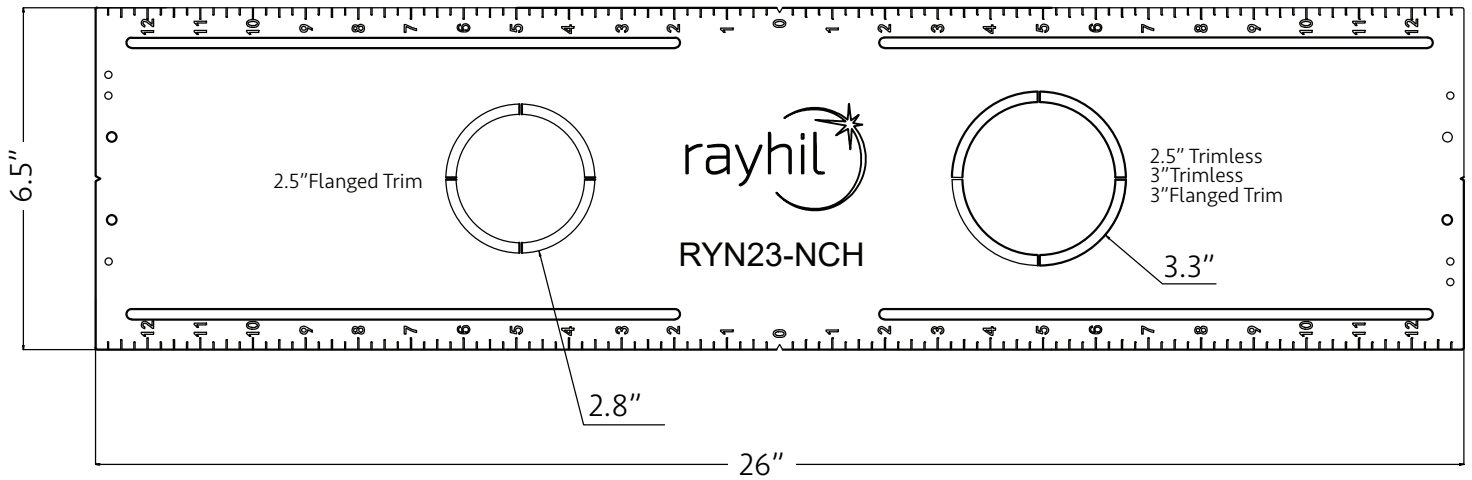



RYNO 3.0

3" RECESSED LED DOWNLIGHT

COMPATIBLE DIMMERS

LUTRON	LOAD (W)
LUTRON MC3J2	300W
LUTRON AYCL-153P	150W
LUTRON SCL-153P	150W
LUTRON DVCL-153P	150W
LUTRON DVSTV-453P	450W

LEVITON	LOAD (W)
LEVITON IPL06	300W
LEVITON 6672	300W
LEVITON 6674	150W
LEVITON DSM10	450W
LEVITON IP710	—

LEGRAND	LOAD (W)
LEGRAND/PS RHCL453P	450W